

Enerdoor is an international leader in the design and manufacturing of standard and custom EMI/RFI filters.

Introduction

Electromagnetic interference (EMI), or radio frequency interference (RFI), is a type of electric or electronic emission that can degrade, impair or prevent electrical circuit performance.

EMI filters are used to suppress interference generated by the device, or by other equipment, and to protect a device from electromagnetic interference signals present in the environment. Most EMI filters consist of components that suppress differential and common mode interference.

To protect and optimize equipment, Enerdoor EMI-RFI filters provide solutions in three product categories: single-phase, three-phase, and three-phase plus neutral filters.

EMC Directive

Electromagnetic Compatibility (EMC) refers to the ability of equipment or systems to operate in an electromagnetic environment without introducing intolerable electromagnetic interference to anything in the environment. EMC includes two important aspects: emission and immunity.

Emission: The phenomenon by which the electromagnetic energy is emitted from a source such as a device, machine or system and shall not emit undesirable electromagnetic interference of a higher level than those allowed by the European EMC Directive 2014/30/EU (See Figure 1).

Immunity (To Interference): The capability of a machine, equipment or system to correctly operate without degrading functional characteristics when affected by electromagnetic interference.

Many countries have established regulations to minimize the radio-frequency interference between electronic equipment including: the CE mark in Europe, FCC in the United States, CCC in China, VCCI in Japan, RCM in Australia & New Zealand, and KCC in South Korea.

The global guideline for electromagnetic interference is the European Directive 2014/30/EU which requires that manufacturers of industrial machine tools and electric and electronic equipment comply with the electromagnetic compatibility emission and immunity Standards.

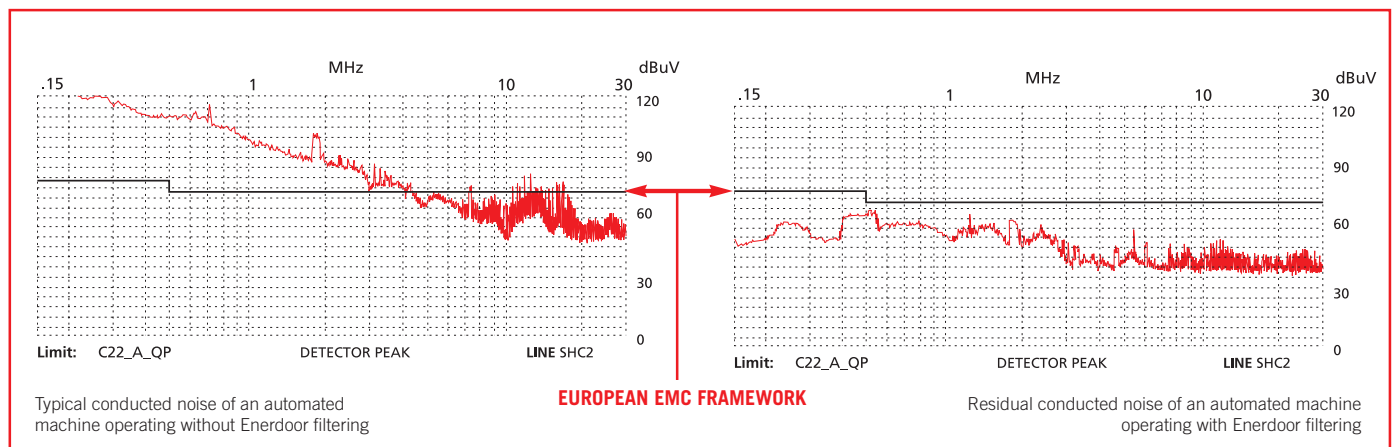

Figure 1:
Example of typical high frequency disturbance generated by an automated machine operating without and with filtering necessary to comply with the European EMC Directive Framework 2014/30/EU limits.

General Classification of Interference

1) Conducted and radiated interference

- a) Conducted interference is caused by the physical contact of undesirable voltage or current signals that enter or exit from a specific device through its own signaling or energizing electric conductors.
- b) Radiated interference is caused without physical contact of conductors. Every electric circuit acts as an aerial and when dipped in an electromagnetic field may induce voltage interference. Every variable current flowing in an electric conductor creates an electromagnetic field in its surrounding environment and similarly each electromagnetic field induces an electric signal in a close conductor.

2) Common mode and differential mode interference

Common mode interference is an undesirable signal measured between all conductors of an electric circuit connected together and a common reference, usually the earth (See Figure A).

Differential mode interference is an undesirable signal measured between two independent conductors of the same electrical circuit (See Figure B).

Problems generated by EMI-RFI interference

- PLCs, sensors, encoders and PCs failing
- Decreased life of sensitive components
- Production downtime
- Disturbance in other buildings/machines

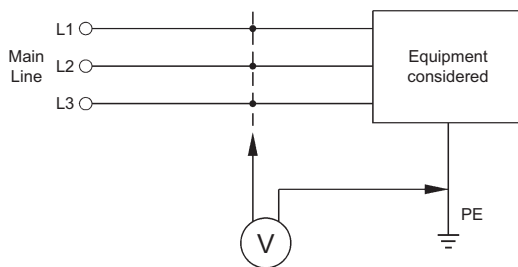

Fig. A: Common Mode Interference

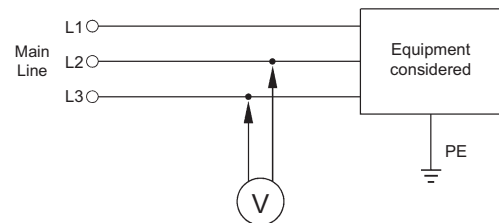

Fig. B: Differential Mode Interference

Figure 2:
Diagram outlining difference between common mode and differential mode interference



Interference Classification

a) Conducted interference due to low frequency phenomena

- Mains 50/60 Hz harmonics and sub-harmonics
- Signaling systems
- Voltage variations, interruptions and dips
- Voltage unbalances
- Mains 50/60 Hz frequency variations
- Low frequency induced voltage
- DC components in AC

b) Conducted interference due to high frequency phenomena

- Induced voltage or current (continuous or modulated waves)
- Voltage transients (bursts)
- Oscillatory transients (single or repetitive)

c) Radiated interference due to low frequency phenomena

- Magnetic fields (transients or continuous)
- Electric fields

d) Radiated interference due to high frequency phenomena

- Magnetic fields
- Electric fields
- Electromagnetic fields (transients, continuous or modulated wave)

High Frequency Solution

To protect and optimize equipment performance, Enerdoor offers one of the largest ranges of solutions to reduce electromagnetic / radio-frequency interference. Offering a large variance of electrical and mechanical characteristics, Enerdoor EMI/RFI filters cover standard nominal voltage from 0 to 750 Vac with the following nominal currents:

Single-phase EMI/RFI filters: from 1 to 75A

Three-phase EMI/RFI filters: from 3 to 75A

Three-phase plus neutral EMI/RFI filters: from 3 to 3000A

Parallel EMI/RFI filters: In addition to the above EMI/RFI filter lines, Enerdoor offers a unique parallel filter solution. This line is designed for the specific frequency range of 50 kHz – 10 MHz where there is severe risk of interference and disturbance.



Filter Selection Guide	Description	Current Range (A)	Voltage	CONNECTORS					FEATURES					APPLICATIONS				Approval		
				Faston	Terminal Blocks	Screws	Bus Bar	Cables	IEC Connector / Faston	Excellent Attenuation	DIN Rail Mount	Long Cable Applications	Low Frequency Attenuation	Compact Design	Suitable for Medical Applications	Power Supply	Automation		Renewable Energy / LED Lights	Medical
Single Phase																				
FIN21	1-phase	3-20	0-250		X						X				X	X			X	UL US
FIN26	1-phase	3-20	0-250		X						X	X			X	X			X	UL US
FIN27	1-phase	3-20	0-250		X					X	X	X				X	X	X	X	UL US
FIN27G	1-phase	3-20	0-250		X					X	X	X	X		X		X	X	X	UL US
FIN33	1-phase	3-75	0-250	X		X								X	X	X				UL US
FIN35	1-phase	5-24	0-250	X	X			X							X		X			
FIN40	1-phase	5-24	0-250	X	X			X							X		X			
FIN50	1-phase	5-24	0-250	X	X					X		X					X	X		
FIN57	1-phase	6-25	0-250	X		X				X		X	X	X			X	X	X	
FIN60	1-phase	1-6	0-250						X						X	X				UL US
FIN70	1-phase	1-6	0-250						X						X	X				UL US
FIN80	1-phase	1-10	0-250						X						X	X				UL US



Single Phase Filters

Single phase EMI/RFI filters are used to bring electrical and electronic products into compliance with national and international EMC Standards.

Enerdoor single phase filters carry CE, UL and CSA approvals and offer a current range from 1 to 75A with nominal voltage up to 250 Vac.

Additional select lines are available up to 690 Vac. For all models, a dedicated low leakage current solution is available for medical applications.

This series features various connections such as: IEC plugs, fastons, terminal blocks, cables, screws, and DIN rail mounting for fast and easy installation within the enclosure.

Single phase EMI/RFI filter applications include:

- Conveyors
- Automated machinery
- Variable frequency drives
- Servo drives
- Medical equipment
- Packaging machinery
- Printing machinery
- Renewable energy
- Power supplies

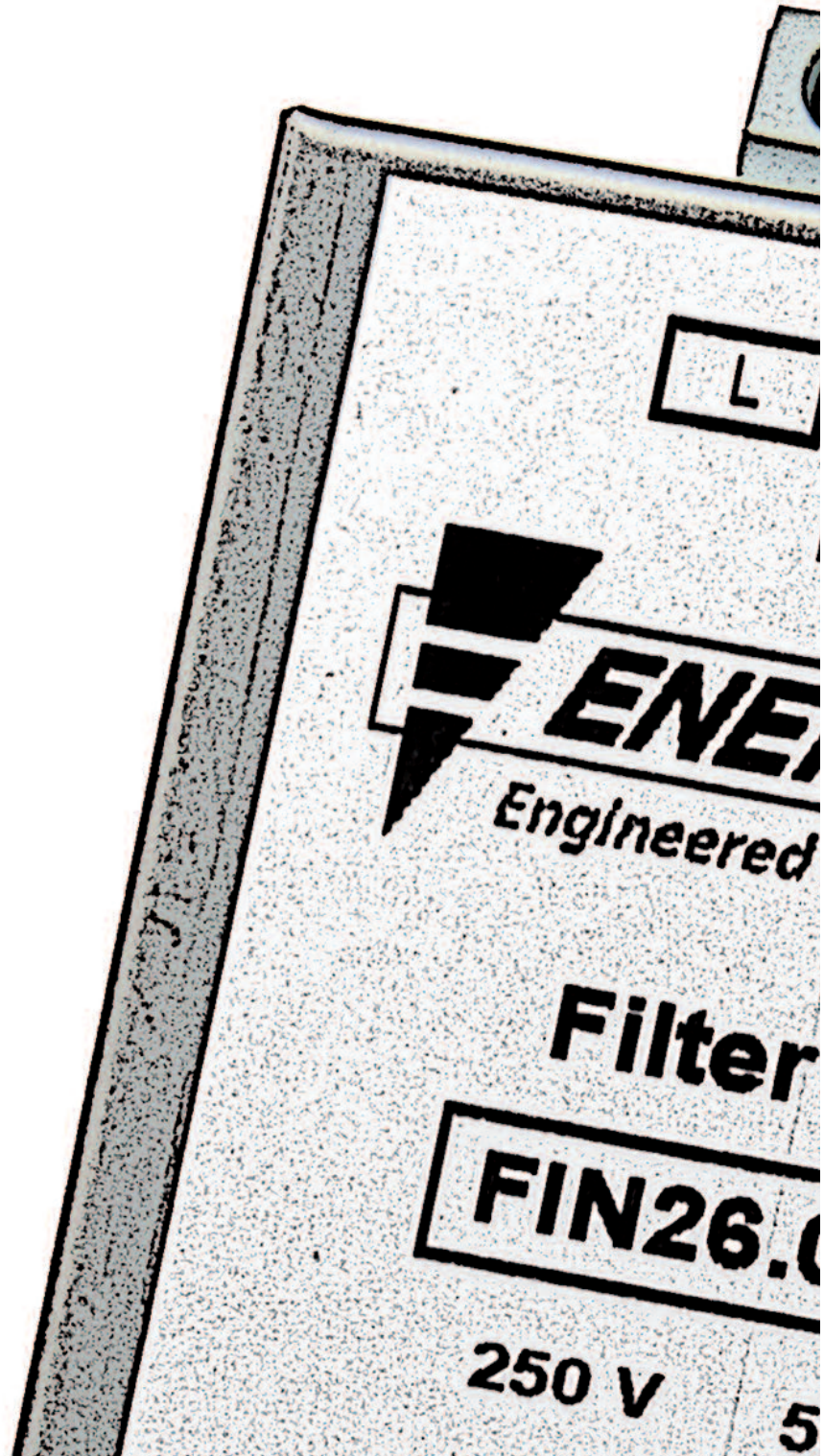



EMI/RFI Filter with high attenuation for industrial applications

Datasheet 3/2019



FIN21.(003 - 020).M

APPROVALS:

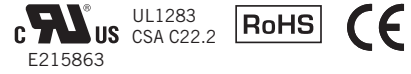

SCCR by UL508A

FEATURES

- Rated current from 3 to 20A
- High differential and common mode attenuation
- Very low leakage current
- DIN rail mounting

BENEFITS

- 5 Year warranty
- Suitable for medical applications
- Compact design

MARKETS

- Conveyors
- Vending machines
- Industrial equipment
- PLCs

ORDERING CODE

FIN21 .016 .M
 Model Current (A) Connection
 M = Terminal block

ATTENUATION INDICATOR

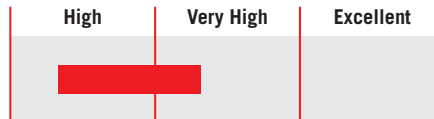

ELECTRIC DIAGRAM

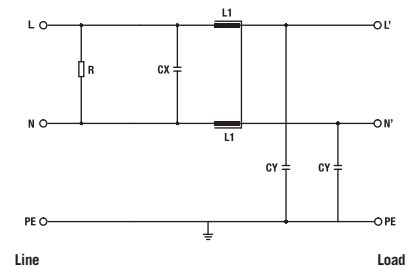

TECHNICAL SPECIFICATIONS

Nominal voltage	0 / 250 Vac
Frequency	50 – 60 Hz
Rated current	3 to 20A
Potential test voltage phase to phase	1750 Vdc (2 sec.)
Potential test voltage phase to ground	2150 Vdc (2 sec.)
Leakage current normal conditions	< 1 mA *
Leakage current worst conditions	< 3 mA
IP Protection	IP20
Overload capability	4 x Rated current (Switch ON) 2 x In 10 seconds 1.5 In for 10 minutes
Climatic class	-40 / +85° C
MTBF at 40°C	250.000 Hrs

* Voltage 230 Vac phase to ground 50 Hz / 40°C

ELECTRICAL CHARACTERISTICS

FIN21	Rated Current 40°C	Rated Current 50°C	Power Loss (W)
.003.M	3	2	1.5
.006.M	6	5	2.1
.010.M	10	8	2.8
.016.M	16	14	3.2
.020.M	20	17	4

CONNECTIONS

LINE			PE
Solid Cable (mm ²)	Stranded Cable (mm ²)	Terminal Block Torque (Nm)	Torque (Nm)
0.2 - 6	0.2 - 4	0.8	0.8
0.2 - 6	0.2 - 4	0.8	0.8
0.2 - 6	0.2 - 4	0.8	0.8
0.2 - 6	0.5 - 4	0.8	0.8
0.2 - 6	0.5 - 4	0.8	0.8

TYPICAL ATTENUATION

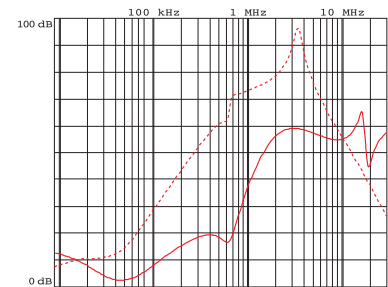

— Common Mode - - - Differential Mode

MECHANICAL DIMENSIONS mm

FIN21	A	B	H	N	Weight Kg.	Case
.003.M	65	85	39	11	0.32	1
.006.M	65	85	39	11	0.32	1
.010.M	65	85	39	11	0.32	1
.016.M	65	85	39	11	0.32	1
.020.M	65	85	39	11	0.32	1

CASE 1

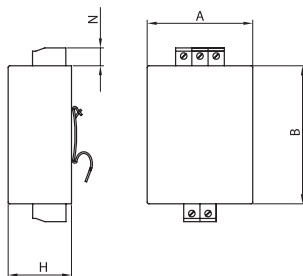

ASSEMBLY CONNECTION "M"

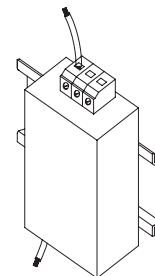



EMI/RFI Filter with very high attenuation for industrial and residential applications

Datasheet 3/2019

APPROVALS:

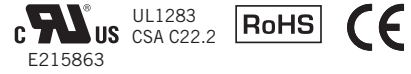

SCCR by UL508A



FIN26.(003 - 020).M

FEATURES

- Rated current from 3 to 20A
- Very low leakage current
- DIN rail mounting
- Panel mounting available

BENEFITS

- 5 Year warranty
- Suitable for medical applications
- Compact design
- Very high differential and common mode attenuation

MARKETS

- Conveyors
- Automated machinery
- Variable frequency drives / servo drives
- Medical equipment

ORDERING CODE

FIN26 .016 .M
 Model Current (A) Connection
 M = Terminal block

ATTENUATION INDICATOR

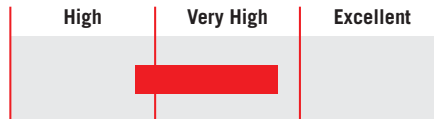

ELECTRIC DIAGRAM

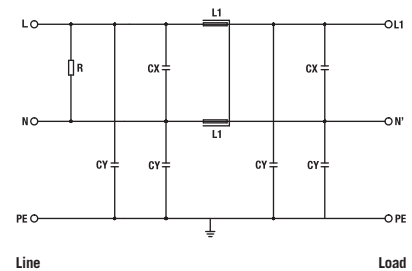

TECHNICAL SPECIFICATIONS

Nominal voltage	0 / 250 Vac
Frequency	50 – 60 Hz
Rated current	3 to 20A
Potential test voltage phase to phase	1750 Vdc (2 sec.)
Potential test voltage phase to ground	2150 Vdc (2 sec.)
Leakage current normal conditions	< 1 mA *
Leakage current worst conditions	< 3 mA
IP Protection	IP20
Overload capability	4 x Rated current (Switch ON) 2 x In 10 seconds 1.5 In for 10 minutes
Climatic class	-40 / +85° C
MTBF at 40°C	250.000 Hrs

* Voltage 230 Vac phase to ground 50 Hz / 40°C

ELECTRICAL CHARACTERISTICS

FIN26	Rated Current 40°C	Rated Current 50°C	Power Loss (W)
.003.M	3	2	1.5
.006.M	6	5	2.1
.010.M	10	8	2.8
.016.M	16	14	3.2
.020.M	20	17	4

CONNECTIONS

LINE			PE
Solid Cable (mm ²)	Stranded Cable (mm ²)	Terminal Block Torque (Nm)	Torque (Nm)
0.2 - 6	0.2 - 4	0.8	0.8
0.2 - 6	0.2 - 4	0.8	0.8
0.2 - 6	0.2 - 4	0.8	0.8
0.2 - 6	0.5 - 4	0.8	0.8
0.2 - 6	0.5 - 4	0.8	0.8

TYPICAL ATTENUATION

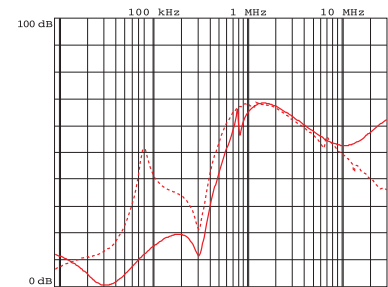

— Common Mode - - - Differential Mode

MECHANICAL DIMENSIONS mm

FIN26	A	B	H	N	Weight Kg.	Case
.003.M	65	85	39	11	0.32	1
.006.M	65	85	39	11	0.32	1
.010.M	65	85	39	11	0.32	1
.016.M	65	85	39	11	0.32	1
.020.M	65	85	39	11	0.32	1

CASE 1

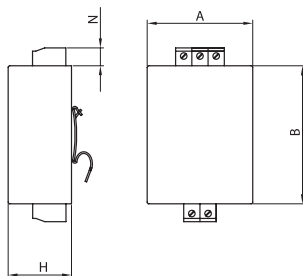

ASSEMBLY CONNECTION "M"

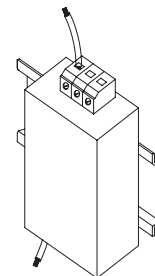



EMI/RFI Filter with excellent attenuation for industrial and residential applications

Datasheet 3/2019

FIN27.(003 - 020).M
FEATURES

- Rated current from 3 to 20A
- Low leakage current
- DIN rail mounting
- Panel mounting available

MARKETS

- Automated machinery
- LED applications
- Variable frequency drives / servo drives
- Medical equipment

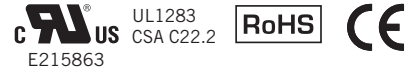
APPROVALS:

SCCR by UL508A

BENEFITS

- 5 Year warranty
- Excellent differential and common mode attenuation
- Compact design
- Helps pass industrial and residential Standards

ORDERING CODE

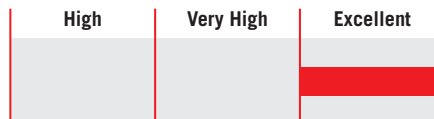
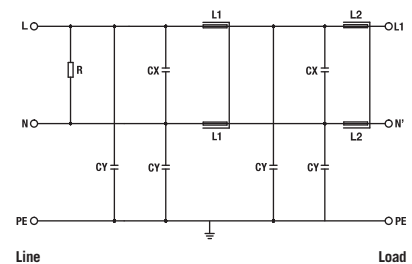
FIN27	.016	.M
Model	Current (A)	Connection
		M = Terminal block

ATTENUATION INDICATOR

ELECTRIC DIAGRAM

TECHNICAL SPECIFICATIONS

Nominal voltage	0 / 250 Vac
Frequency	50 – 60 Hz
Rated current	3 to 20A
Potential test voltage phase to phase	1750 Vdc (2 sec.)
Potential test voltage phase to ground	2150 Vdc (2 sec.)
Leakage current normal conditions	< 1 mA *
Leakage current worst conditions	< 3 mA
IP Protection	IP20
Overload capability	4 x Rated current (Switch ON) 2 x In 10 seconds 1.5 In for 10 minutes
Climatic class	-40 / +85° C
MTBF at 40°C	250.000 Hrs

* Voltage 230 Vac phase to ground 50 Hz / 40°C

ELECTRICAL CHARACTERISTICS

FIN27	Rated Current 40°C	Rated Current 50°C	Power Loss (W)
.003.M	3	2	1.5
.006.M	6	5	2.1
.010.M	10	8	2.8
.016.M	16	14	3.2
.020.M	20	17	4

CONNECTIONS

LINE			PE
Solid Cable (mm ²)	Stranded Cable (mm ²)	Terminal Block Torque (Nm)	Torque (Nm)
0.2 - 6	0.2 - 4	0.8	0.8
0.2 - 6	0.2 - 4	0.8	0.8
0.2 - 6	0.2 - 4	0.8	0.8
0.2 - 6	0.5 - 4	0.8	0.8
0.2 - 6	0.5 - 4	0.8	0.8

TYPICAL ATTENUATION

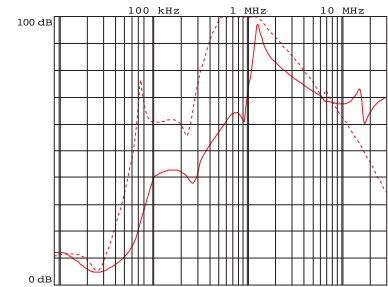

— Common Mode - - - Differential Mode

MECHANICAL DIMENSIONS mm

FIN27	A	B	H	N	Weight Kg.	Case
.003.M	65	85	39	11	0.32	1
.006.M	65	85	39	11	0.32	1
.010.M	65	85	39	11	0.32	1
.016.M	65	85	39	11	0.32	1
.020.M	65	85	39	11	0.32	1

CASE 1

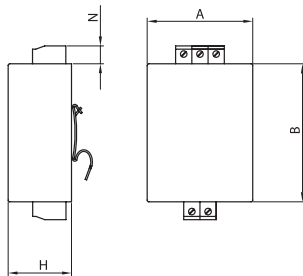

ASSEMBLY CONNECTION "M"

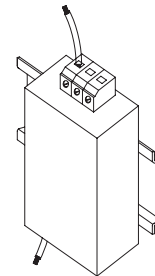



Datasheet 3/2019

EMI/RFI Filter with excellent attenuation for industrial, residential and medical applications

APPROVALS:

UL1283
CSA C22.2
E215863



SCCR by UL508A



FIN27G.(003 – 020).M

FEATURES

- Rated current from 3 to 20A
- Low leakage current
- DIN rail mounting
- Panel mounting available

BENEFITS

- 5 Year warranty
- Excellent differential and common mode attenuation
- Compact design
- Designed for medical applications

MARKETS

- Automated machinery
- CNC machinery
- Variable frequency drives / servo drives
- Medical equipment

ORDERING CODE

FIN27G .016 .M
Model Current (A) Connection
M = Terminal block

ATTENUATION INDICATOR

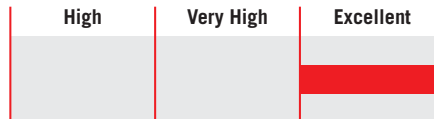

ELECTRIC DIAGRAM

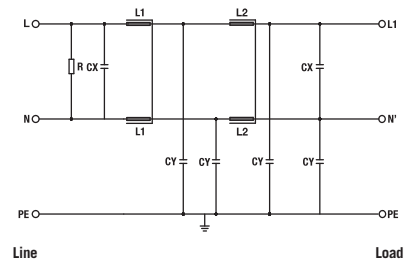

TECHNICAL SPECIFICATIONS

Nominal voltage	0 / 250 Vac
Frequency	50 – 60 Hz
Rated current	3 to 20A
Potential test voltage phase to phase	1750 Vdc (2 sec.)
Potential test voltage phase to ground	2150 Vdc (2 sec.)
Leakage current normal conditions	< 0.4 mA *
Leakage current worst conditions	< 1.5 mA
IP Protection	IP20
Overload capability	4 x Rated current (Switch ON) 2 x In 10 seconds 1.5 In for 10 minutes
Climatic class	-40 / +85° C
MTBF at 40°C	250.000 Hrs

* Voltage 230 Vac phase to ground 50 Hz / 40°C

ELECTRICAL CHARACTERISTICS

FIN27G	Rated Current 40°C	Rated Current 50°C	Power Loss (W)
.003.M	3	2	1.5
.006.M	6	5	2.1
.010.M	10	8	2.8
.016.M	16	14	3.2
.020.M	20	17	4

CONNECTIONS

LINE			PE
Solid Cable (mm ²)	Stranded Cable (mm ²)	Terminal Block Torque (Nm)	Torque (Nm)
0.2 - 6	0.2 - 4	0.8	0.8
0.2 - 6	0.2 - 4	0.8	0.8
0.2 - 6	0.2 - 4	0.8	0.8
0.2 - 6	0.5 - 4	0.8	0.8
0.2 - 6	0.5 - 4	0.8	0.8

TYPICAL ATTENUATION

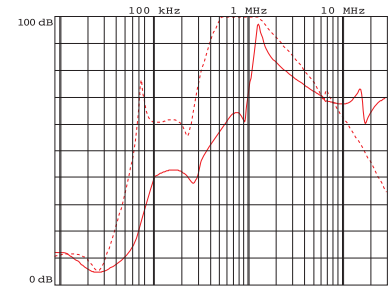

— Common Mode - - - Differential Mode

MECHANICAL DIMENSIONS mm

FIN27G	A	B	H	N	Weight Kg.	Case
.003.M	65	85	39	11	0.32	1
.006.M	65	85	39	11	0.32	1
.010.M	65	85	39	11	0.32	1
.016.M	65	85	39	11	0.32	1
.020.M	65	85	39	11	0.32	1

CASE 1

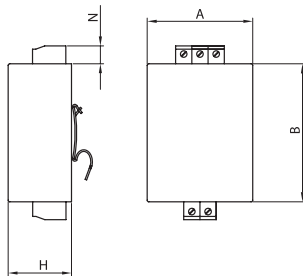

ASSEMBLY CONNECTION "M"

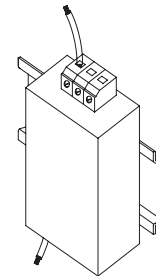



EMI/RFI Filter with high attenuation for industrial and residential applications

Datasheet 3/2019

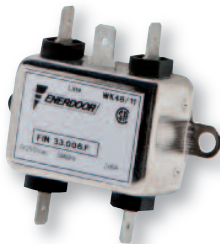
APPROVALS:

FIN33.(003 – 020).F
FEATURES

- Rated current from 3 to 75A
- Very low leakage current
- Faston connections
- Panel mounting

BENEFITS

- 5 Year warranty
- High differential and common mode attenuation
- Very compact design
- Excellent quality and value

MARKETS

- Conveyors
- Vending machinery
- Power supplies
- Medical equipment

ORDERING CODE

FIN33	.020	.F
Model	Current (A)	Connection
		F = Faston
		V = Screws

FIN33.(040 – 075).V
ATTENUATION INDICATOR

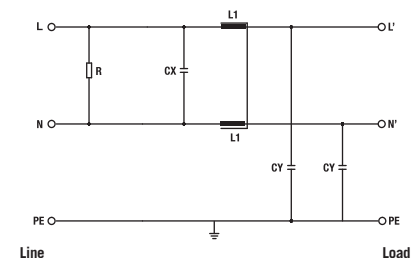
ELECTRIC DIAGRAM

TECHNICAL SPECIFICATIONS

Nominal voltage	0 / 250 Vac
Frequency	50 – 60 Hz
Rated current	3 to 75A
Potential test voltage phase to phase	1750 Vdc (2 sec.)
Potential test voltage phase to ground	2150 Vdc (2 sec.)
Leakage current normal conditions	< 1 mA *
Leakage current worst conditions	< 3 mA
IP Protection	IP00
Overload capability	4 x Rated current (Switch ON) 2 x In 10 seconds 1.5 In for 10 minutes
Climatic class	-40 / +85° C
MTBF at 40°C	250.000 Hrs

* Voltage 230 Vac phase to ground 50 Hz / 40°C

ELECTRICAL CHARACTERISTICS

FIN33	Rated Current 40°C	Rated Current 50°C	Power Loss (W)
.003.F	3	2	1.5
.006.F	6	5	2.1
.010.F	10	8	2.8
.020.F	20	16	3.8
.040.V	40	32	4.5
.050.V	50	40	5.5
.075.V	75	60	7

CONNECTIONS

LINE			PE	
Solid Cable (mm ²)	Stranded Cable (mm ²)	Terminal Torque (Nm)	d1 (mm)	Torque (Nm)
0.2 - 6	0.5 - 4	-	-	-
0.2 - 6	0.5 - 4	-	-	-
0.2 - 6	0.5 - 4	-	-	-
0.2 - 6	0.5 - 4	-	-	-
-	-	4	M5	4
-	-	6	M6	4
-	-	14	M8	4

TYPICAL ATTENUATION

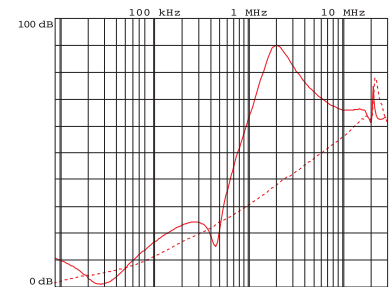

— Common Mode - - - Differential Mode

MECHANICAL DIMENSIONS mm

FIN33	A	B	V	F	H	I	L	N	d	Weight Kg.	Case
.003.F	20.5	33	14	5	66	45	56	-	6.5	0.13	1
.006.F	20.5	33	14	5	66	45	56	-	6.5	0.13	1
.010.F	20.5	33	14	5	66	45	56	-	6.5	0.2	1
.020.F	39	51.8	14	5	84	65	74	-	6.5	0.18	2
.040.V	40	86.6	20	6x4	107	100	55	96	M5	0.18	3
.050.V	50	100	25	6x4	125	180	120	115	M6	0.30	4
.075.V	72	120	30	8x4	152	182	120	135	M8	0.40	5

CASE 1

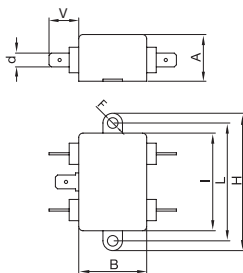

ASSEMBLY CONNECTION "F"

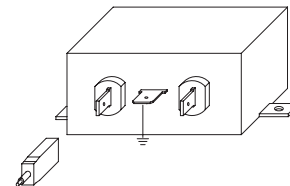

CASE 2

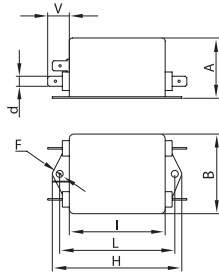

ASSEMBLY CONNECTION "F"

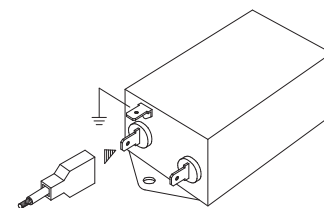

CASE 3, 4, 5

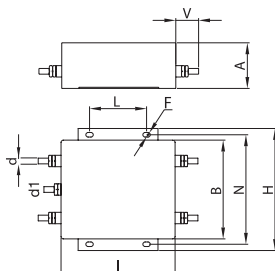

ASSEMBLY CONNECTION "V"

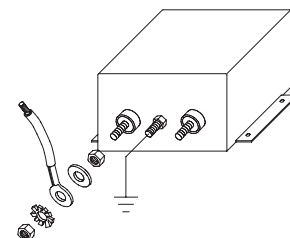



EMI/RFI Filter with high attenuation for industrial applications

Datasheet 3/2019

APPROVALS:



FIN35.(005 - 016).F

FEATURES

- Rated current from 5 to 24A
- Low leakage current
- Faston connections
- Panel mounting

BENEFITS

- 5 Year warranty
- High differential and common mode attenuation
- Compact design
- Suitable for medical applications

MARKETS

- Automated machinery
- Medical equipment
- Power supplies
- Conveyors

ORDERING CODE

FIN35	.016	.F
Model	Current (A)	Connection
		F = Faston
		M = Terminal block



FIN35.024.M

ATTENUATION INDICATOR

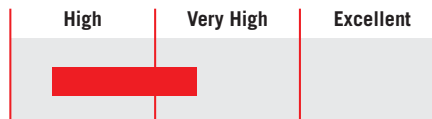

ELECTRIC DIAGRAM

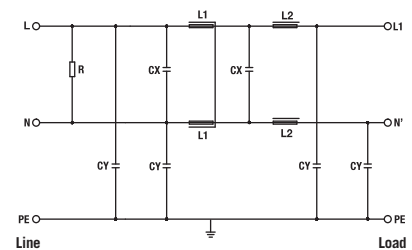

TECHNICAL SPECIFICATIONS

Nominal voltage	0 / 250 Vac
Frequency	50 – 60 Hz
Rated current	5 to 24A
Potential test voltage phase to phase	1750 Vdc (2 sec.)
Potential test voltage phase to ground	2150 Vdc (2 sec.)
Leakage current normal conditions	< 1 mA *
Leakage current worst conditions	< 3 mA
IP Protection	IP00 up to 16A – over IP20
Overload capability	4 x Rated current (Switch ON) 2 x In 10 seconds 1.5 In for 10 minutes
Climatic class	-40 / +85° C
MTBF at 40°C	250.000 Hrs

* Voltage 230 Vac phase to ground 50 Hz / 40°C

ELECTRICAL CHARACTERISTICS

FIN35	Rated Current 40°C	Rated Current 50°C	Power Loss (W)
.005.F	5	3	2
.010.F	10	7	2.7
.016.F	16	12	5
.024.M	24	20	6

CONNECTIONS

LINE			PE
Solid Cable (mm ²)	Stranded Cable (mm ²)	Terminal Block Torque (Nm)	Torque (Nm)
0.2 - 6	0.5 - 4	-	-
0.2 - 6	0.5 - 4	-	-
0.2 - 6	0.5 - 4	-	-
0.2 - 6	0.5 - 4	0.8	0.8

TYPICAL ATTENUATION

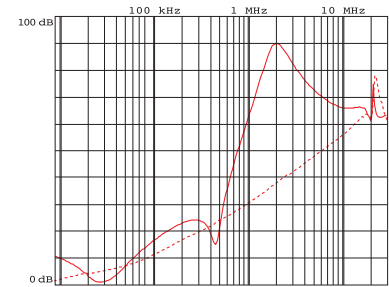

— Common Mode - - - Differential Mode

MECHANICAL DIMENSIONS mm

FIN35	A	B	V	F	H	I	L	N	d	Weight Kg.	Case
.005.F	29	51	13.5	4.5	84.5	63.5	74.5	-	6.5	0.13	1
.010.F	33	51	13.5	4.5	84.5	63.5	74.5	-	6.5	0.18	2
.016.F	39.5	51	13.5	4.5	97	75.5	86.5	-	6.5	0.26	3
.024.M	49.5	51	13	4.5	70	93	51	60	-	0.46	4

CASE 1, 2, 3

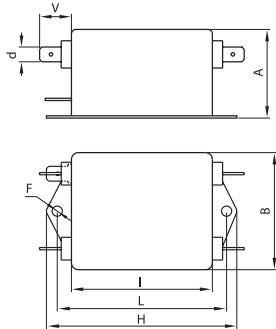

ASSEMBLY CONNECTION "F"

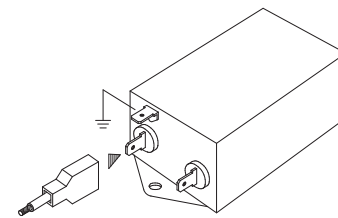

CASE 4

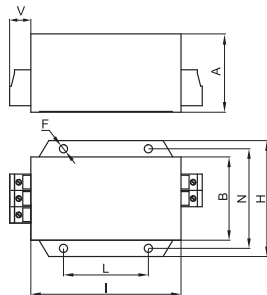

ASSEMBLY CONNECTION "M"

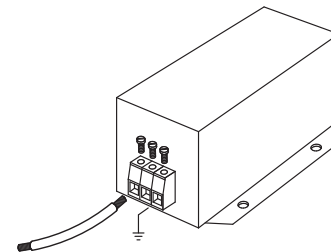



EMI/RFI Filter with very high attenuation for industrial applications

Datasheet 3/2019

APPROVALS:

FIN40.(005 - 016).F
FEATURES

- Rated current from 5 to 24A
- Low leakage current
- Faston connections
- Panel mounting

BENEFITS

- 5 Year warranty
- Very high differential and common mode attenuation
- Compact design
- Suitable for medical applications

MARKETS

- Conveyors
- CNC machinery
- Variable frequency drives / servo drives
- Medical equipment

ORDERING CODE

FIN40	.016	.F
Model	Current (A)	Connection
		F = Faston
		M = Terminal block

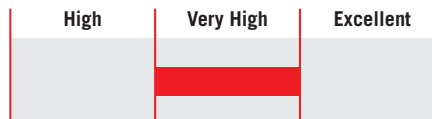
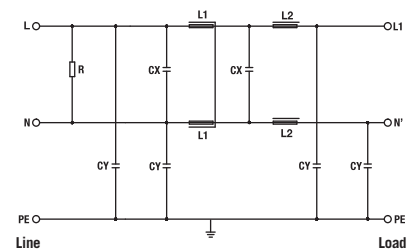
FIN40.024.M
ATTENUATION INDICATOR

ELECTRIC DIAGRAM

TECHNICAL SPECIFICATIONS

Nominal voltage	0 / 250 Vac
Frequency	50 – 60 Hz
Rated current	5 to 24A
Potential test voltage phase to phase	1750 Vdc (2 sec.)
Potential test voltage phase to ground	2150 Vdc (2 sec.)
Leakage current normal conditions	< 1.5 mA *
Leakage current worst conditions	< 5 mA
IP Protection	IP20
Overload capability	4 x Rated current (Switch ON) 2 x In 10 seconds 1.5 In for 10 minutes
Climatic class	-40 / +85° C
MTBF at 40°C	250.000 Hrs

* Voltage 230 Vac phase to ground 50 Hz / 40°C

ELECTRICAL CHARACTERISTICS

FIN40	Rated Current 40°C	Rated Current 50°C	Power Loss (W)
.005.F	5	3	2
.010.F	10	7	2.7
.016.F	16	12	5
.024.M	24	20	6

CONNECTIONS

LINE			PE
Solid Cable (mm ²)	Stranded Cable (mm ²)	Terminal Block Torque (Nm)	Torque (Nm)
0.2 - 6	0.5 - 4	-	-
0.2 - 6	0.5 - 4	-	-
0.2 - 6	0.5 - 4	-	-
0.2 - 6	0.5 - 4	0.8	0.8

TYPICAL ATTENUATION

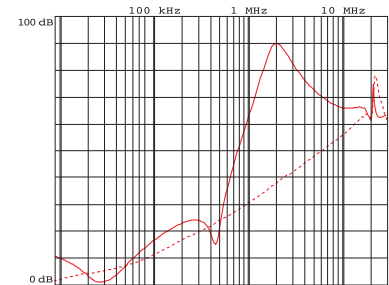

— Common Mode - - - Differential Mode

MECHANICAL DIMENSIONS mm

FIN40	A	B	V	F	H	I	L	N	d	Weight Kg.	Case
.005.F	29	51	13.5	4.5	84.5	63.5	74.5	-	6.5	0.13	1
.010.F	33	51	13.5	4.5	84.5	63.5	74.5	-	6.5	0.18	2
.016.F	39.5	51	13.5	4.5	97	75.5	86.5	-	6.5	0.26	3
.024.M	49.5	51	13	4.5	70	93	51	60	-	0.46	4

CASE 1, 2, 3

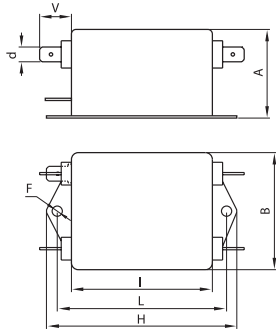

ASSEMBLY CONNECTION "F"

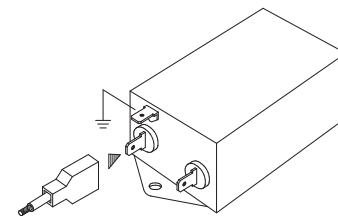

CASE 4

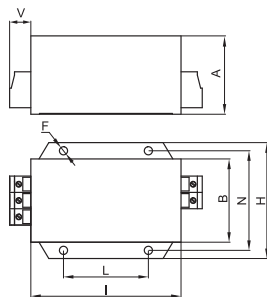

ASSEMBLY CONNECTION "M"

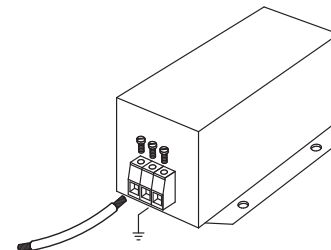



EMI/RFI Filter with excellent attenuation for industrial applications

Datasheet 3/2019

APPROVALS:



FIN50.(005 - 016).F

FEATURES

- Rated current from 5 to 24A
- Low leakage current
- Panel mounting

BENEFITS

- 5 Year warranty
- High differential and common mode attenuation
- High performance

MARKETS

- Packaging machinery
- Renewable energy
- CNC machinery
- Printing machinery

ORDERING CODE

FIN50 .016 .F
 Model Current (A) Connection
 F = Faston
 M = Terminal block



FIN50.024.M

ATTENUATION INDICATOR



ELECTRIC DIAGRAM

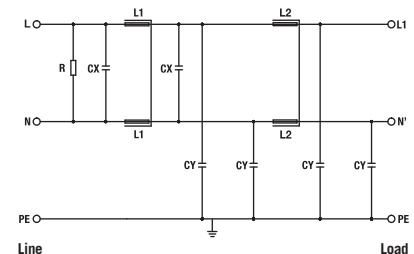

TECHNICAL SPECIFICATIONS

Nominal voltage	0 / 250 Vac
Frequency	50 – 60 Hz
Rated current	5 to 24A
Potential test voltage phase to phase	1750 Vdc (2 sec.)
Potential test voltage phase to ground	2150 Vdc (2 sec.)
Leakage current normal conditions	< 2.2 mA *
Leakage current worst conditions	< 7 mA
IP Protection	IP00 up to 16A – over IP20
Overload capability	4 x Rated current (Switch ON) 2 x In 10 seconds 1.5 In for 10 minutes
Climatic class	-40 / +85° C
MTBF at 40°C	250.000 Hrs

* Voltage 230 Vac phase to ground 50 Hz / 40°C

ELECTRICAL CHARACTERISTICS

FIN50	Rated Current 40°C	Rated Current 50°C	Power Loss (W)
.005.F	5	3	2
.010.F	10	7	2.7
.016.F	16	12	5
.024.M	24	20	6

CONNECTIONS

LINE			PE
Solid Cable (mm ²)	Stranded Cable (mm ²)	Terminal Block Torque (Nm)	Torque (Nm)
0.2 - 6	0.5 - 4	-	-
0.2 - 6	0.5 - 4	-	-
0.2 - 6	0.5 - 4	-	-
0.2 - 6	0.5 - 4	0.8	0.8

TYPICAL ATTENUATION

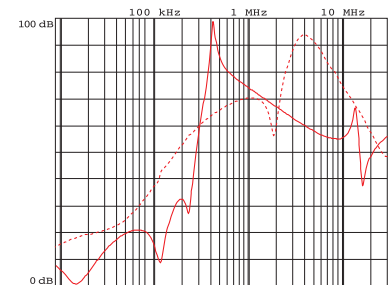

— Common Mode - - - Differential Mode

MECHANICAL DIMENSIONS mm

FIN50	A	B	V	F	H	I	L	N	d	Weight Kg.	Case
.005.F	39	51	13.5	4.5	84.5	63.5	74.5	-	6.5	0.20	1
.010.F	49.5	51	13.5	4.5	97	75.5	86.5	-	6.5	0.35	2
.016.F	45	84.5	13.5	4.5	105	99.5	51	95	6.5	0.70	3
.024.M	49.5	84.5	13	4.5	105	99.5	51	95	-	0.93	4

CASE 1, 2

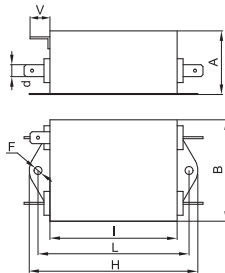

ASSEMBLY CONNECTION "F"

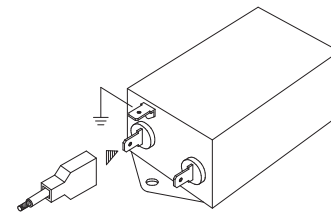

CASE 3

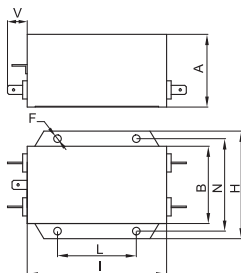

ASSEMBLY CONNECTION "F"

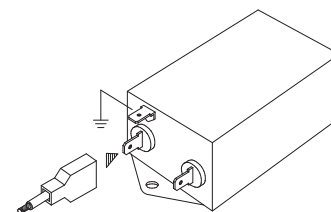

CASE 4

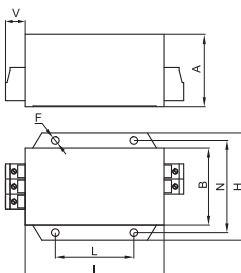

ASSEMBLY CONNECTION "M"

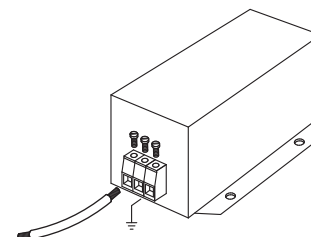



EMI/RFI Filter with excellent attenuation for industrial applications

Datasheet 3/2019

APPROVALS:

FIN57.(006 – 016).F
FEATURES

- Rated current from 6 to 25A
- Low leakage current
- Excellent performance

BENEFITS

- 5 Year warranty
- Excellent differential and common mode attenuation
- Compact design

MARKETS

- Packaging machinery
- Renewable energy
- CNC machinery
- Printing machinery

ORDERING CODE

FIN57	.016	.F
Model	Current (A)	Connection
		F = Faston
		V = Screw

FIN57.025.V
ATTENUATION INDICATOR

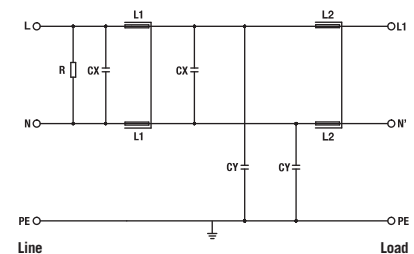
ELECTRIC DIAGRAM

TECHNICAL SPECIFICATIONS

Nominal voltage	0 / 250 Vac
Frequency	50 – 60 Hz
Rated current	6 to 25A
Potential test voltage phase to phase	1750 Vdc (2 sec.)
Potential test voltage phase to ground	2150 Vdc (2 sec.)
Leakage current normal conditions	< 2.2 mA *
Leakage current worst conditions	< 7 mA
IP Protection	IP00
Overload capability	4 x Rated current (Switch ON) 2 x In 10 seconds 1.5 In for 10 minutes
Climatic class	-40 / +85° C
MTBF at 40°C	250.000 Hrs

* Voltage 230 Vac phase to ground 50 Hz / 40°C

ELECTRICAL CHARACTERISTICS

FIN57	Rated Current 40°C	Rated Current 50°C	Power Loss (W)
.006.F	6	4	2
.010.F	10	7	2.7
.016.F	16	12	5
.025.V	25	20	6

CONNECTIONS

LINE			PE	
Solid Cable (mm ²)	Stranded Cable (mm ²)	Terminal Torque (Nm)	d1 (mm)	Torque (Nm)
0.2 - 6	0.5 - 4	-	-	-
0.2 - 6	0.5 - 4	-	-	-
0.2 - 6	0.5 - 4	-	-	-
-	-	-	M4	3

TYPICAL ATTENUATION

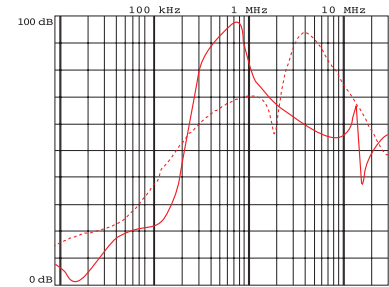

— Common Mode - - - Differential Mode

MECHANICAL DIMENSIONS mm

FIN57	A	B	C	D	E	F	G	V	d	d1	Weight Kg.	Case
.006.F	93	57	45	113	103	4.75	-	12.7	6.3	-	0.45	1
.010.F	93	57	45	113	103	4.75	-	12.7	6.3	-	0.47	1
.016.F	98.5	85.5	57.6	119	109	4.4	51	12.7	6.3	-	0.59	2
.025.V	130.5	56	45	156	143	6	-	15	M4	M4	0.61	3

CASE 1

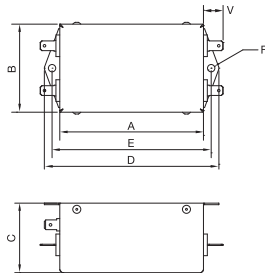

ASSEMBLY CONNECTION "F"

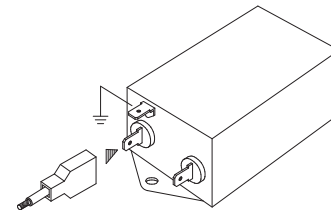

CASE 2

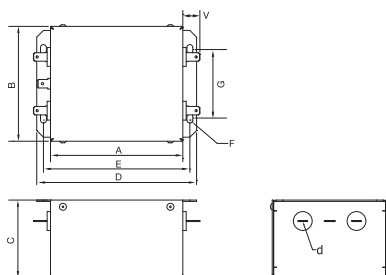

ASSEMBLY CONNECTION "F"

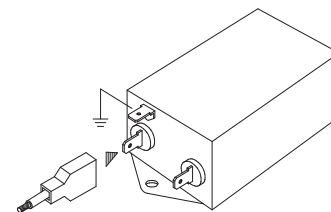

CASE 3

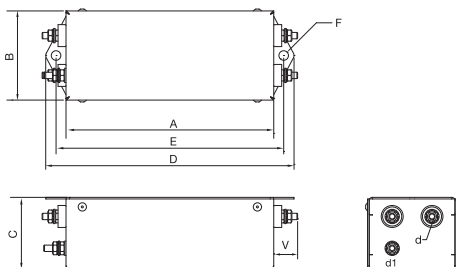

ASSEMBLY CONNECTION "V"

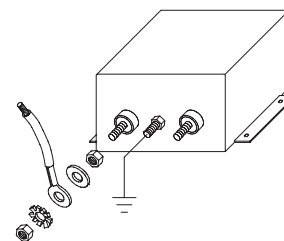



EMI/RFI Filter with high attenuation for industrial and residential applications

Datasheet 3/2019

APPROVALS:

FIN60.(001 – 006).VF

FEATURES

- Rated current from 1 to 6A
- Very low leakage current
- Compact design

BENEFITS

- 5 Year warranty
- High differential and common mode attenuation
- Easy installation
- Suitable for medical applications

MARKETS

- Instrumentation
- Vending machinery
- Printing machinery
- Medical equipment

ORDERING CODE

FIN60	.006	.VF
Model	Current (A)	Connection
		VF = Faston

ATTENUATION INDICATOR

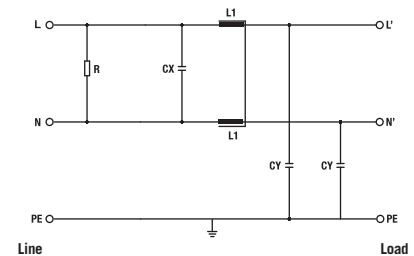
ELECTRIC DIAGRAM

TECHNICAL SPECIFICATIONS

Nominal voltage	0 / 250 Vac
Frequency	50 – 60 Hz
Rated current	1 to 6A
Potential test voltage phase to phase	1450 Vdc (2 sec.)
Potential test voltage phase to ground	2150 Vdc (2 sec.)
Leakage current normal conditions	< 1 mA *
Leakage current worst conditions	< 3 mA
IP Protection	IP00
Overload capability	4 x Rated current (Switch ON) 2 x In 10 seconds 1.5 In for 10 minutes
Climatic class	-40 / +85° C
MTBF at 40°C	250.000 Hrs

* Voltage 230 Vac phase to ground 50 Hz / 40°C

ELECTRICAL CHARACTERISTICS

FIN60	Rated Current 40°C	Rated Current 50°C	Power Loss (W)
.001.VF	1	0.7	1
.003.VF	3	2.4	2
.006.VF	6	4	3

CONNECTIONS

LINE			PE
Solid Cable (mm ²)	Stranded Cable (mm ²)	Terminal Block Torque (Nm)	Torque (Nm)
0.2 - 6	0.5 - 4	-	-
0.2 - 6	0.5 - 4	-	-
0.2 - 6	0.5 - 4	-	-

TYPICAL ATTENUATION

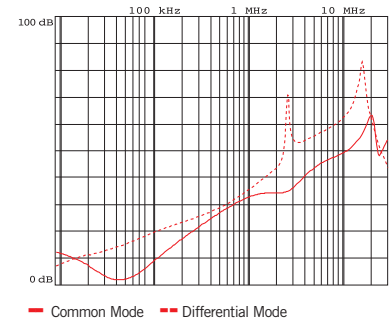

MECHANICAL DIMENSIONS mm

FIN60	A	B	V	F	H	I	L	C	E	G	d	Weight Kg.	Case
.001.VF	40	22	14	3.5	40	31	23	7	24	50	6.5	0.10	1
.003.VF	40	22	14	3.5	40	31	23	7	24	50	6.5	0.10	1
.006.VF	40	22	14	3.5	40	31	23	7	24	50	6.5	0.11	1

CASE 1

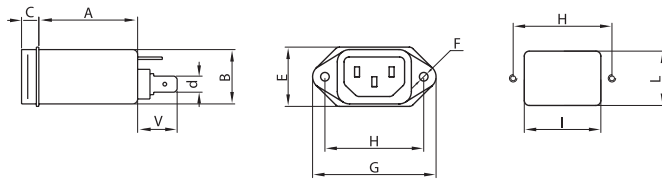

ASSEMBLY CONNECTION "VF"

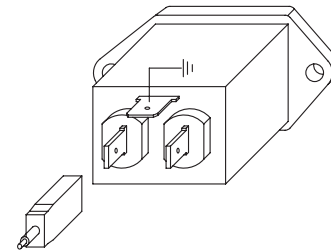



EMI/RFI Filter with high attenuation for industrial and residential applications

Datasheet 3/2019

APPROVALS:



FIN70.(001 – 006).VF

FEATURES

- Rated current from 1 to 6A
- Very low leakage current
- Fuse integrated

BENEFITS

- 5 Year warranty
- High differential and common mode attenuation
- Compact design
- Suitable for medical applications

MARKETS

- Instrument and testing machinery
- Vending machinery
- Printing machinery
- Medical equipment

ORDERING CODE

FIN70	.006	.VF
Model	Current (A)	Connection
		VF = Faston

ATTENUATION INDICATOR

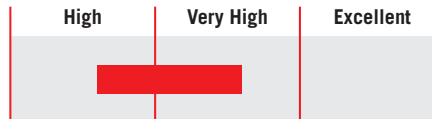

ELECTRIC DIAGRAM

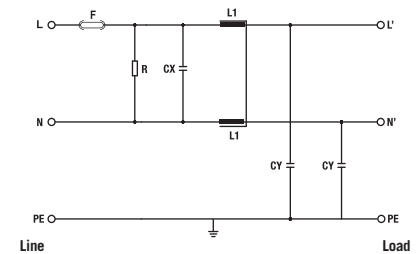

TECHNICAL SPECIFICATIONS

Nominal voltage	0 / 250 Vac
Frequency	50 – 60 Hz
Rated current	1 to 6A
Potential test voltage phase to phase	1450 Vdc (2 sec.)
Potential test voltage phase to ground	2150 Vdc (2 sec.)
Leakage current normal conditions	< 1 mA *
Leakage current worst conditions	< 3 mA
IP Protection	IP00
Overload capability	4 x Rated current (Switch ON) 2 x In 10 seconds 1.5 In for 10 minutes
Climatic class	-40 / +85° C
MTBF at 40°C	250.000 Hrs

* Voltage 230 Vac phase to ground 50 Hz / 40°C

ELECTRICAL CHARACTERISTICS

FIN70	Rated Current 40°C	Rated Current 50°C	Power Loss (W)
.001.VF	1	0.7	1
.003.VF	3	2.4	2
.006.VF	6	4	3

CONNECTIONS

LINE		PE	
Solid Cable (mm ²)	Stranded Cable (mm ²)	Terminal Block Torque (Nm)	Torque (Nm)
0.2 - 6	0.5 - 4	-	-
0.2 - 6	0.5 - 4	-	-
0.2 - 6	0.5 - 4	-	-

TYPICAL ATTENUATION

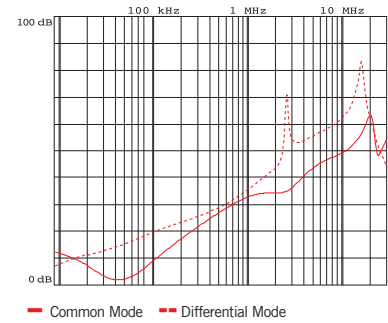

MECHANICAL DIMENSIONS mm

FIN70	A	B	V	F	H	I	L	C	E	G	d	Weight Kg.	Case
.001.VF	40	33	14	3.5	36	29.5	33.5	7	36	45	6.5	0.12	1
.003.VF	40	33	14	3.5	36	29.5	33.5	7	36	45	6.5	0.12	1
.006.VF	40	33	14	3.5	36	29.5	33.5	7	36	45	6.5	0.12	1

CASE 1

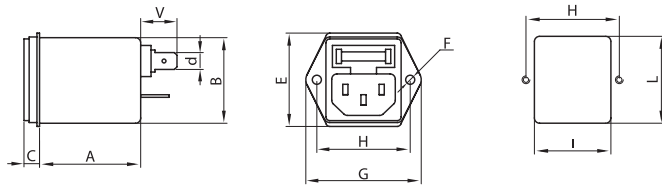

ASSEMBLY CONNECTION "VF"

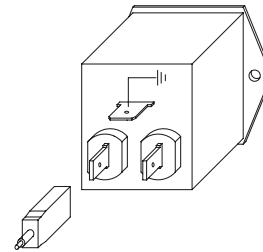



EMI/RFI Filter with very high attenuation for industrial and residential applications

Datasheet 3/2019

APPROVALS:



FIN80.(001 – 010).VFI

FEATURES

- Rated current from 1 to 10A
- Very low leakage current
- Integrated fuse and power switch

BENEFITS

- 5 Year warranty
- Very high differential and common mode attenuation
- Compact design
- Suitable for medical applications

MARKETS

- Instrument and testing machinery
- Vending machinery
- Printing machinery
- Medical equipment

ORDERING CODE

FIN80	.006	VFI
Model	Current (A)	Connection
		VFI = Faston with switch

ATTENUATION INDICATOR

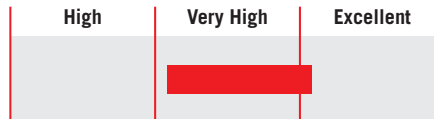

ELECTRIC DIAGRAM

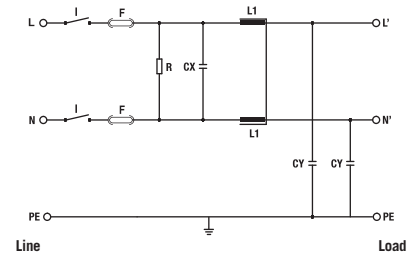

TECHNICAL SPECIFICATIONS

Nominal voltage	0 / 250 Vac
Frequency	50 – 60 Hz
Rated current	1 to 10A
Potential test voltage phase to phase	1450 Vdc (2 sec.)
Potential test voltage phase to ground	2150 Vdc (2 sec.)
Leakage current normal conditions	< 1 mA *
Leakage current worst conditions	< 3 mA
IP Protection	IP00
Overload capability	4 x Rated current (Switch ON) 2 x In 10 seconds 1.5 In for 10 minutes
Climatic class	-40 / +85° C
MTBF at 40°C	250.000 Hrs

* Voltage 230 Vac phase to ground 50 Hz / 40°C

ELECTRICAL CHARACTERISTICS

FIN80	Rated Current 40°C	Rated Current 50°C	Power Loss (W)
.001.VFI	1	0.7	1
.003.VFI	3	2.5	2
.006.VFI	6	4	3
.010.VFI	10	8	5

CONNECTIONS

LINE			PE
Solid Cable (mm ²)	Stranded Cable (mm ²)	Terminal Block Torque (Nm)	Torque (Nm)
02. - 6	02. - 6	-	-
02. - 6	02. - 6	-	-
02. - 6	02. - 6	-	-
02. - 6	02. - 6	-	-

TYPICAL ATTENUATION

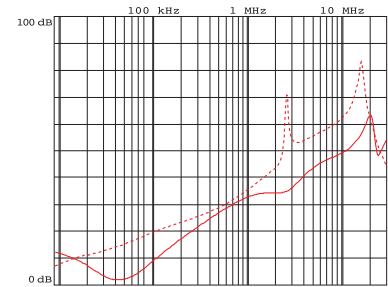

— Common Mode - - - Differential Mode

MECHANICAL DIMENSIONS mm

FIN80	A	B	V	F	H	I	L	C	E	G	d	Weight Kg.	Case
.001.VFI	39	61	14	3.5	40	30	62	6	50	65	6.5	0.20	1
.003.VFI	39	61	14	3.5	40	30	62	6	50	65	6.5	0.20	1
.006.VFI	39	61	14	3.5	40	30	62	6	50	65	6.5	0.21	1
.010.VFI	39	61	14	3.5	40	30	62	6	50	65	6.5	0.22	1

CASE 1

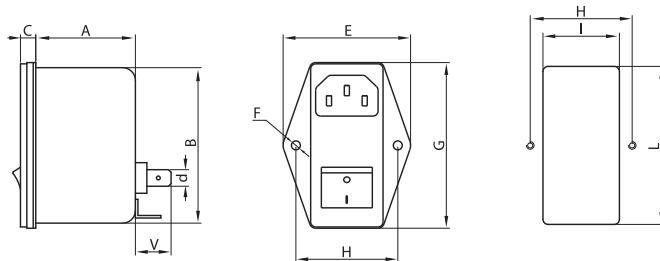

ASSEMBLY CONNECTION "VFI"

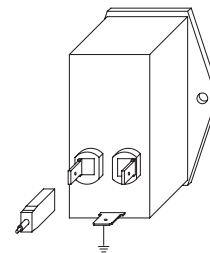



Filter Selection Guide	Description	Voltage	CONNECTORS					FEATURES					APPLICATIONS					Approval	
			Faston	Terminal Blocks	Screws	Bus Bar	Cables	IEC Connector/ Faston	DIN Rail Mount	Long Cable Applications	High Att. Low Frequency	Book Case Style	Low Leakage Current	Multiple Drives	Automation	Renewable Energy	Commercial Building		Recharging Station
Parallel Filters																			
FIN130SP	3-phase	0-600		X					X	X	X				X		X		
FIN230SP	3-phase	0-600		X					X	X	X		X	X	X				
FIN730	3-phase	0-750		X					X		X		X	X	X		X		
FIN735	3-phase	0-650		X					X							X			
FIN740	3-phase plus neutral	0-600		X					X	X	X		X	X	X		X		

Enerdoor parallel filters provide protection from variable frequency drives, SCRs, controllers, and other high commutation electrical equipment. This line provides high attenuation in the frequency range of 10 kHz to 5 MHz offering a solution for applications with low to medium frequency concerns. When used in conjunction with other Enerdoor filters, this combination ensures EMI/RFI protection for equipment in any environment.

This series offers a unique solution available with nominal voltage up to 750 Vac and any current level due to the parallel connection to the line. Offered in 3 phase and 3 phase plus neutral, this line carries CE and UL approvals.

The FIN730 and FIN740 filters reduce EMI interference in the 30 kHz to 10 MHz frequency range. The FIN230 filter has a resonance frequency of 150 kHz and provides a significant interference reduction in the frequency range of 50 kHz to 5 MHz. This series features panel and DIN rail mounting for fast and easy installation.

Parallel filter applications include:

- CNC machinery
- Recharging stations
- Multiple drive applications
- Renewable energy
- SCR applications

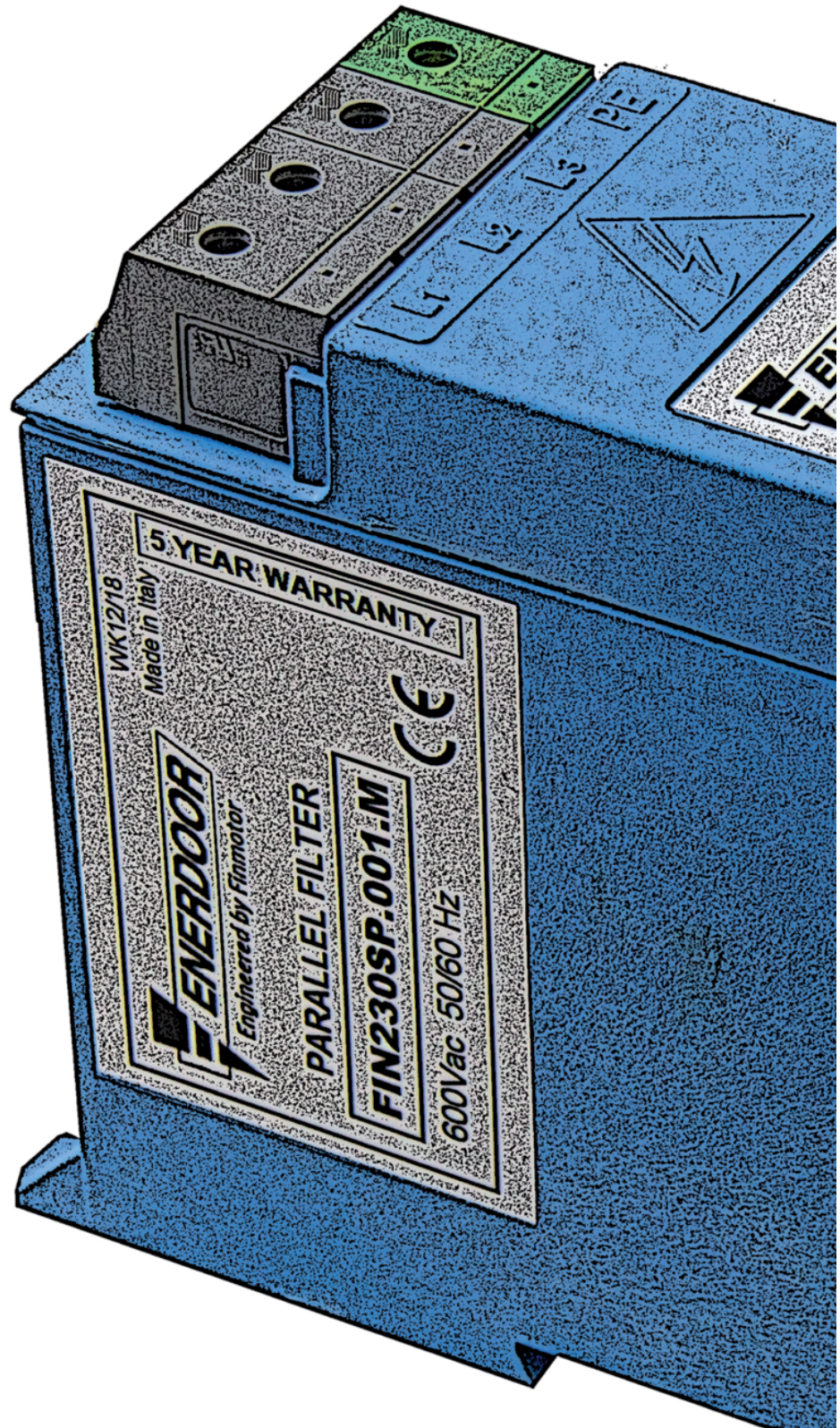

EMI/RFI Parallel filter with excellent attenuation in low frequency range

Datasheet 3/2019

APPROVALS:

FIN130SP.001.M
FEATURES

- Independent from nominal current
- Low leakage current
- DIN rail or panel mounting
- Excellent attenuation in low frequency range

BENEFITS

- 5 Year warranty
- High differential and common mode attenuation
- Compact design
- Easy installation

FIN230SP.001.M
MARKETS

- CNC machinery
- Recharging stations
- Multiple drive applications
- Renewable energy

ORDERING CODE

FIN 230SP	.001	.M
Model		Connection
		M = Terminal Blocks

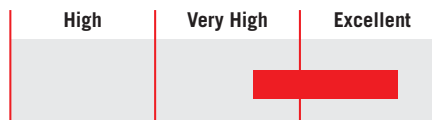
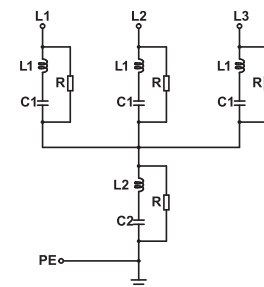
FIN735.001.M
ATTENUATION INDICATOR

ELECTRIC DIAGRAM

TECHNICAL SPECIFICATIONS

Nominal voltage	See Electrical Characteristics
Frequency	50 – 60 Hz
Rated current	Unlimited
Potential test voltage phase to phase	2400 Vdc (2 sec.)
Potential test voltage phase to ground	3200 Vdc (2 sec.)
Leakage current normal conditions	< 25 mA *
Leakage current worst conditions	< 70 mA
IP Protection	IP20
Climatic class	-40 / +85° C
MTBF at 40°C	250.000 Hrs

* Voltage 230 Vac phase to ground 50H / 40°C

ELECTRICAL CHARACTERISTICS

Model	Nominal Voltage AC (Vac)	Nominal Voltage DC (Vdc)	Power Loss (W)
FIN130SP.001.M	600	1000	10
FIN230SP.001.M	600	1000	10
FIN735.001.M	650	1100	10

CONNECTIONS

LINE			PE
Solid Cable (mm ²)	Stranded Cable (mm ²)	Terminal Block Torque (Nm)	Torque (Nm)
1 - 4	1 - 4	1.8	1.8
1 - 4	1 - 4	1.8	1.8
1 - 4	1 - 4	1.8	1.8

TYPICAL ATTENUATION

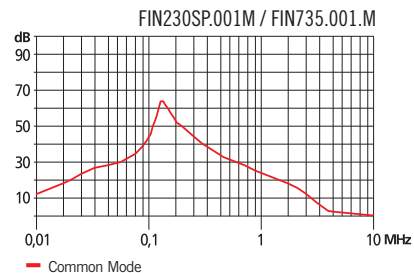
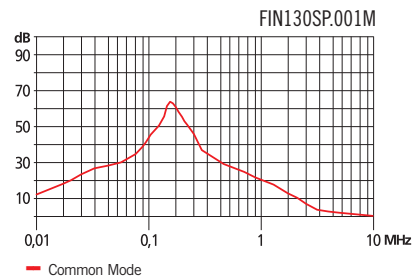

MECHANICAL DIMENSIONS mm

Model	L	d	E	I	P	A	C	T	G	F	H	Weight Kg.	Case
FIN130SP.001.M	59	4.5	10	35	130	112	166	4	37.5	7	146	1.15	1
FIN230SP.001.M	59	4.5	10	35	130	112	166	4	37.5	7	146	1.15	1
FIN735.001.M	59	4.5	10	35	130	112	166	4	37.5	7	146	1.15	1

CASE 1

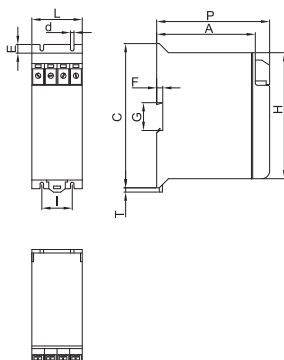

ASSEMBLY CONNECTION "M"

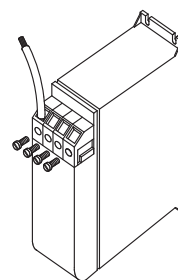



Datasheet 3/2019

EMI/RFI Parallel filter with excellent attenuation in low frequency range

APPROVALS:



UL1283
CSA C22.2



FIN730.001.M (C - LCP)

FEATURES

- Independent from nominal current
- Low leakage current
- DIN rail or panel mounting
- Excellent attenuation in low frequency range

BENEFITS

- 5 Year warranty
- High differential and common mode attenuation
- Compact design
- Easy installation

MARKETS

- CNC machinery
- Recharging stations
- Multiple drive applications
- Renewable energy

ORDERING CODE

FIN 730.001. .M
Model Nominal voltage
M = 750Vac
MC = 600Vac
MLCP = 480Vac

ATTENUATION INDICATOR

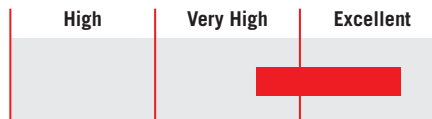

ELECTRIC DIAGRAM

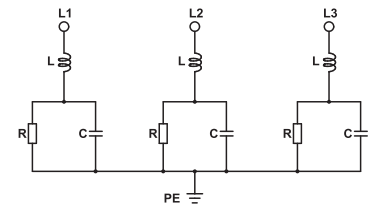

TECHNICAL SPECIFICATIONS

Nominal voltage	See Electrical Characteristics
Frequency	50 – 60 Hz
Rated current	Unlimited
Potential test voltage phase to phase	2400 Vdc (2 sec.)
Potential test voltage phase to ground	3200 Vdc (2 sec.)
Leakage current normal conditions	< 25 mA *
Leakage current worst conditions	< 70 mA
IP Protection	IP20
Climatic class	-40 / +85° C
MTBF at 40°C	250.000 Hrs

* Voltage 230 Vac phase to ground 50 Hz / 40°C

ELECTRICAL CHARACTERISTICS

Model	Nominal Voltage AC (Vac)	Nominal Voltage DC (Vdc)	Power Loss (W)
FIN730.001.M	750	1200	10
FIN730.002.MC	600	1000	10
FIN730.001.MLCP	480	800	10

CONNECTIONS

LINE			PE
Solid Cable (mm ²)	Stranded Cable (mm ²)	Terminal Block Torque (Nm)	Torque (Nm)
1 - 4	1 - 4	1.8	1.8
1 - 4	1 - 4	1.8	1.8
1 - 4	1 - 4	1.8	1.8

TYPICAL ATTENUATION



MECHANICAL DIMENSIONS mm

Model	L	d	E	I	P	A	C	T	G	F	H	Weight Kg.	Case
FIN730.001.M	59	4.5	10	35	130	112	166	4	37.5	7	146	1.15	1
FIN730.002.MC	59	4.5	10	35	130	112	166	4	37.5	7	146	1.15	1
FIN730.001.MLCP	59	4.5	10	35	130	112	166	4	37.5	7	146	1.15	1

CASE 1

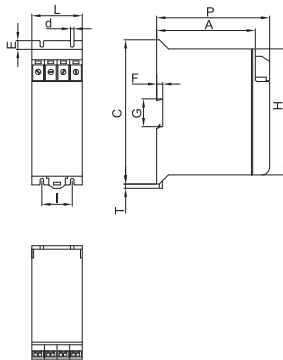

ASSEMBLY CONNECTION "M"

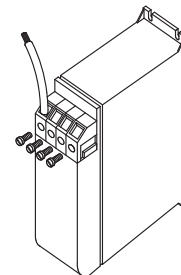



EMI/RFI Parallel filter with excellent attenuation in low frequency range

Datasheet 3/2019

APPROVALS:

UL1283
CSA C22.2
E215863



FIN740.068.M

FEATURES

- Independent from nominal current
- Low leakage current
- DIN rail or panel mounting
- Excellent attenuation in low frequency range

BENEFITS

- 5 Year warranty
- High differential and common mode attenuation
- Compact design
- 3-phase plus neutral application

MARKETS

- CNC machinery
- Recharging stations
- Multiple drive applications
- Renewable energy

ORDERING CODE

FIN740 .068 .M
Model Connection
M = Terminal block

ATTENUATION INDICATOR



ELECTRIC DIAGRAM

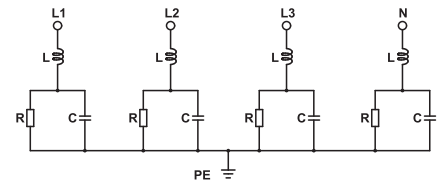

TECHNICAL SPECIFICATIONS

Nominal voltage	0 / 600 Vac
Frequency	50 – 60 Hz
Rated current	Unlimited
Potential test voltage phase to phase	2200 Vdc (2 sec.)
Potential test voltage phase to ground	2900 Vdc (2 sec.)
Leakage current normal conditions	<20 mA*
Leakage current worst conditions	<60 mA
IP Protection	IP20
Climatic class	-40 / +85° C
MTBF at 40°C	250.000 Hrs

* Voltage 230 Vac phase to ground 50 Hz / 40°C

ELECTRICAL CHARACTERISTICS

Model	Nominal Voltage AC (Vac)	Nominal Voltage DC (Vdc)	Power Loss (W)
FIN740.068.M	480	800	10

CONNECTIONS

LINE			PE
Solid Cable (mm ²)	Stranded Cable (mm ²)	Terminal Block Torque (Nm)	Torque (Nm)
1 - 4	1 - 4	1.8	1.8

TYPICAL ATTENUATION

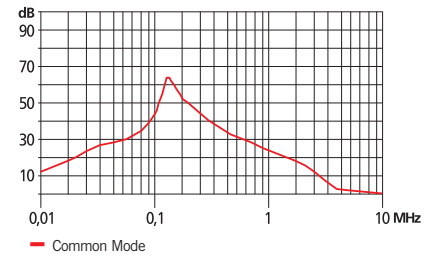

MECHANICAL DIMENSIONS mm

Model	L	d	E	I	P	A	C	T	G	F	H	Weight Kg.	Case
FIN740.068.M	59	4.5	10	35	130	112	166	4	37.5	7	146	1.15	1

CASE 1

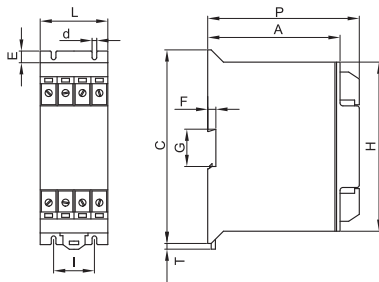

ASSEMBLY CONNECTION "M"

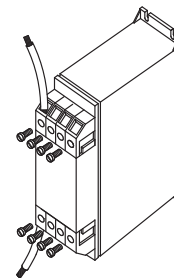



Filter Selection Guide	Description	Current Range (A)	Voltage	CONNECTORS			FEATURES						APPLICATIONS					Approval
				Terminal Blocks	Screws	Bus Bar	Regenerative Systems	DIN Rail Mount	Long Cable Applications	Low Frequency Attenuation	Book Case Style	Very Low Leakage Current	Machine Tools	Automation	Renewable Energy	IT Network	Medical	
Three Phase																		
FIN1351	3-phase	6-16	0-480	X				X					X				X	
FIN538	3-phase	5-30	0-480	X				X						X				
FIN538S	3-phase	7-180	0-600	X	X	X			X					X	X			C UL US
FIN538S1	3-phase	7-3000	0-600	X	X	X	X		X		X		X	X	X			C UL US
FIN539S	3-phase	400-2500	0-600			X	X		X		X							
FIN1200	3-phase	5-3000	0-480		X	X							X				X	C UL US
FIN1200HV	3-phase	5-3000	0-600		X	X							X				X	C UL US
FIN1500	3-phase	5-3000	0-480		X	X	X		X	X			X			X		C UL US
FIN1500HV	3-phase	5-3000	0-600		X	X	X		X	X			X			X		C UL US
FIN1600	3-phase	7-200	0-480	X					X		X							
FIN1700	3-phase	6-200	0-600	X									X	X			X	C UL US
FIN1700G	3-phase	6-200	0-600	X					X		X	X		X			X	C UL US
FIN1700E	3-phase	7-230	0-500	X									X	X			X	C UL US
FIN1700EG	3-phase	7-230	0-500	X									X	X			X	C UL US
FIN1700IT	3-phase	6-200	0-600	X	X	X							X				X	
FIN1900	3-phase	6-200	0-600	X			X						X	X	X			C UL US
FIN1900G	3-phase	6-200	0-600	X			X		X				X	X	X			C UL US
FIN1900E	3-phase	6-230	0-500	X									X	X	X			C UL US
FIN1900EG	3-phase	6-230	0-500	X					X				X	X	X			C UL US
FIN1900S	3-phase	42-200	0-600	X			X		X	X			X	X	X			C UL US
FIN3755	3-phase	7-280	0-480	X										X				C UL US
FIN7213	3-phase	150-3000	0-480			X	X		X	X				X	X			

Enerdoor three phase filters provide high attenuation in a compact case with low leakage current and are suitable for a large range of industries. Enerdoor offers solutions in traditional TN and TNS networks and in specific applications such as IT power line configurations.

This line carries CE, UL and CSA approvals and offers a current range from 5 to 3000A with nominal voltage up to 750 Vac.

This series features easy installation and is available with DIN rail mounting, bus bar connectors, safety terminal blocks and finger safe protection. Customized solutions are available to satisfy various application requirements.

Three phase applications include:

- Automated machinery
- Packaging machinery
- Variable frequency drives
- Servo drives
- IT networks
- Medical equipment
- CNC machinery
- HVAC systems
- Recharging stations
- Renewable energy
- Uninterruptible power supplies

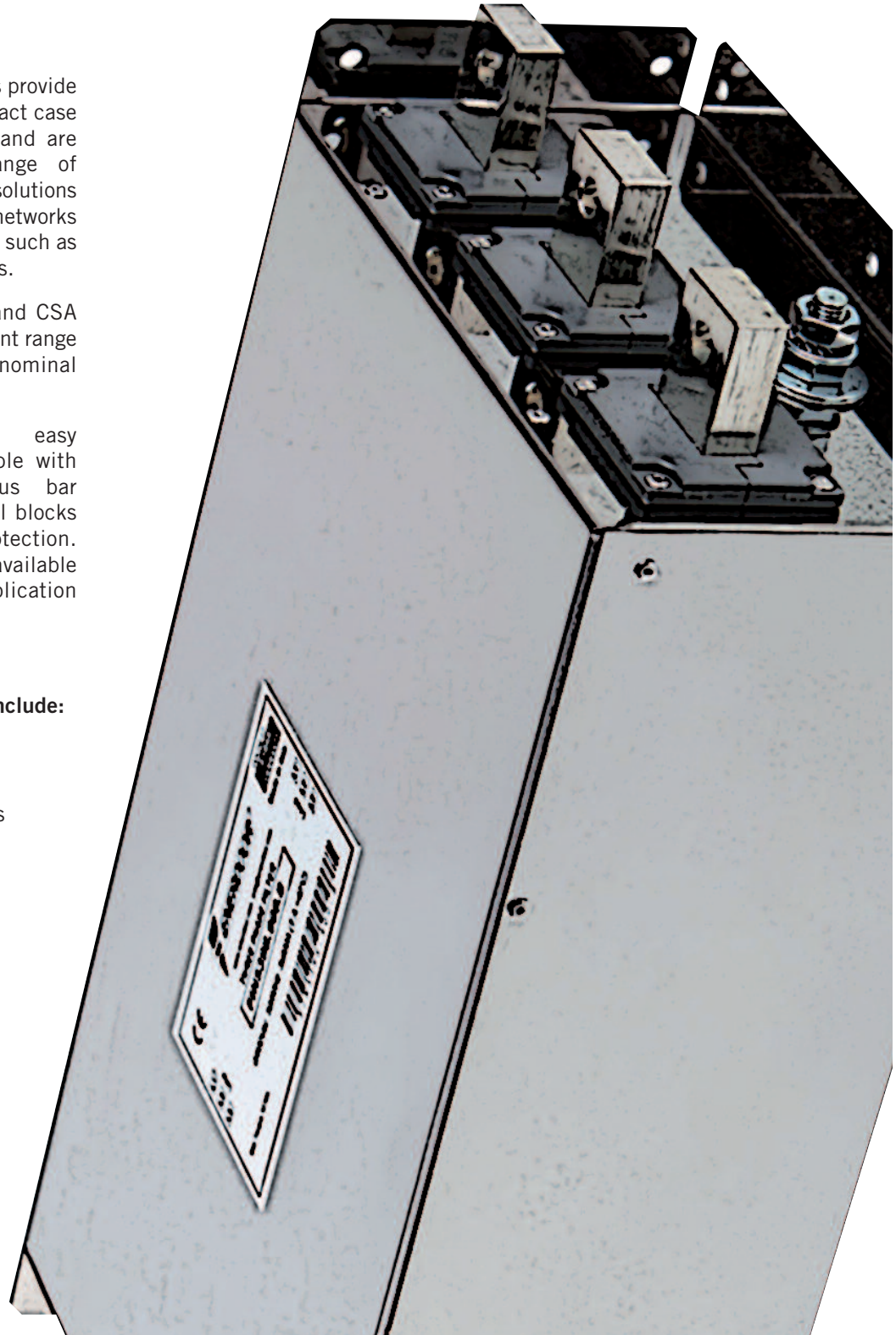



EMI/RFI filter with high attenuation for industrial and residential applications

Datasheet 3/2019

APPROVALS:



FIN1351.(006 - 016).M

FEATURES

- Rated current from 6 to 16A
- Very low leakage current
- DIN rail mounting

BENEFITS

- 5 Year warranty
- Suitable for medical applications
- Very compact design
- Protects equipment

MARKETS

- Conveyors
- Testing equipment
- High tech machinery
- Automated machinery

ORDERING CODE

FIN1351 .016 .M
 Model Current (A) Connection
 M = Terminal block

ATTENUATION INDICATOR

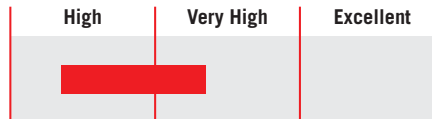

ELECTRIC DIAGRAM

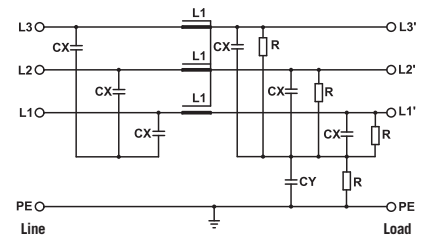

TECHNICAL SPECIFICATIONS

Nominal voltage	0 / 480 Vac
Frequency	50 – 60 Hz
Rated current	6 to 16A
Potential test voltage phase to phase	2200 Vdc (2 sec.)
Potential test voltage phase to ground	2900 Vdc (2 sec.)
Leakage current normal conditions	< 3 mA *
Leakage current worst conditions	< 5 mA
IP Protection	IP20
Overload capability	4 x Rated current (Switch ON) 2 x In 10 seconds 1.5 In for 10 minutes
Climatic class	-40 / +85° C
MTBF at 40°C	250.000 Hrs

* Voltage 230 Vac phase to ground 50 Hz / 40°C

ELECTRICAL CHARACTERISTICS

FIN1351	Rated Current 40°C	Rated Current 50°C	Power Loss (W)
.006.M	6	5	6
.010.M	10	8	8
.016.M	16	14	10

CONNECTIONS

LINE			PE
Solid Cable (mm ²)	Stranded Cable (mm ²)	Terminal Block Torque (Nm)	Torque (Nm)
0.2 - 6	0.2 - 4	0.8	0.8
0.2 - 6	0.2 - 4	0.8	0.8
0.2 - 6	0.2 - 4	0.8	0.8

TYPICAL ATTENUATION

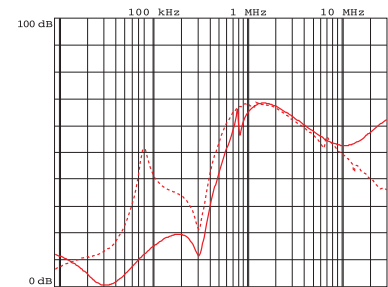

— Common Mode - - - Differential Mode

MECHANICAL DIMENSIONS mm

FIN1351	A	B	H	N	Weight Kg.	Case
.006.M	65	85	39	11	0.32	1
.010.M	65	85	39	11	0.32	1
.016.M	65	85	39	11	0.32	1

CASE 1

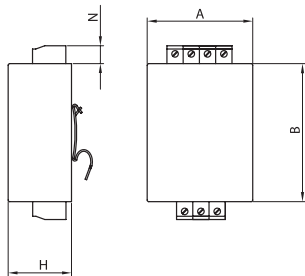

ASSEMBLY CONNECTION "M"

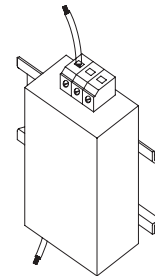



EMI/RFI Filter with high attenuation for industrial applications

Datasheet 3/2019

APPROVALS:



FIN538.(005 - 030).M

FEATURES

- Rated current from 5 to 30A
- High differential and common mode attenuation
- Low leakage current
- DIN rail mounting

BENEFITS

- 5 Year warranty
- Easy installation
- Very compact design
- Helps pass immunity and emission tests for the IEC61000-6-2 and IEC61000-6-4 Standards

MARKETS

- Conveyors
- Testing equipment
- High tech machinery
- Automated machinery

ORDERING CODE

FIN538 .016 .M
 Model Current (A) Connection
 M = Terminal block

ATTENUATION INDICATOR

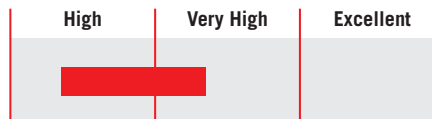

ELECTRIC DIAGRAM

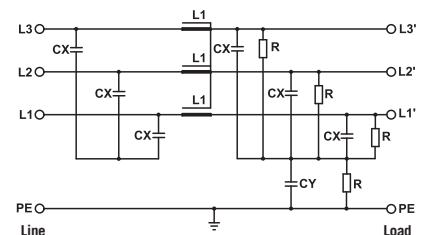

TECHNICAL SPECIFICATIONS

Nominal voltage	0 / 480 Vac
Frequency	50 – 60 Hz
Rated current	5 to 30A
Potential test voltage phase to phase	2200 Vdc (2 sec.)
Potential test voltage phase to ground	2900 Vdc (2 sec.)
Leakage current normal conditions	< 10 mA *
Leakage current worst conditions	< 80 mA
IP Protection	IP20
Overload capability	4 x Rated current (Switch ON) 2 x In 10 seconds 1.5 In for 10 minutes
Climatic class	-40 / +85° C
MTBF at 40°C	250.000 Hrs

* Voltage 230 Vac phase to ground 50 Hz / 40°C

ELECTRICAL CHARACTERISTICS

FIN538	Rated Current 40°C	Rated Current 50°C	Power Loss (W)
.005.M	8	6	8
.010.M	14	12	10
.016.M	18	16	12
.025.M	28	25	15
.030.M	35	32	23

CONNECTIONS

LINE			PE
Solid Cable (mm ²)	Stranded Cable (mm ²)	Terminal Block Torque (Nm)	Torque (Nm)
1 - 4	1 - 4	1.8	1.8
1 - 4	1 - 4	1.8	1.8
1 - 4	1 - 4	1.8	1.8
1 - 4	1 - 4	1.8	1.8
1 - 4	1 - 4	1.8	1.8

TYPICAL ATTENUATION

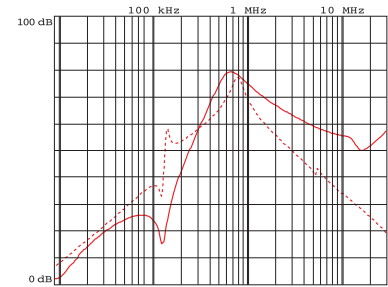

— Common Mode - - - Differential Mode

MECHANICAL DIMENSIONS mm

FIN538	A	E	C	P	F	H	I	L	G	d	T	Weight Kg.	Case
.005.M	112	10	166	130	7	146	35	59	37.5	4.5	4	1.15	1
.010.M	112	10	166	130	7	146	35	59	37.5	4.5	4	1.15	1
.016.M	112	10	166	130	7	146	35	59	37.5	4.5	4	1.15	1
.025.M	112	10	166	130	7	146	35	59	37.5	4.5	4	1.15	1
.030.M	112	10	166	130	7	146	35	59	37.5	4.5	4	1.15	1

CASE 1

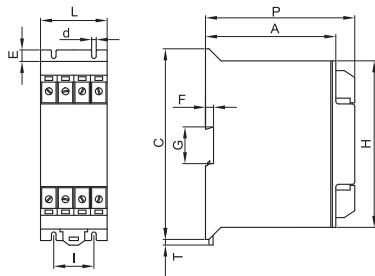

ASSEMBLY CONNECTION "M"

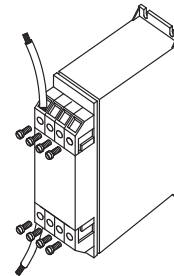



EMI/RFI Filter with very high attenuation for industrial applications

Datasheet 3/2019

APPROVALS:

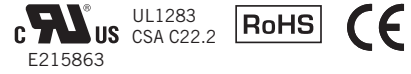

SCCR by UL508A



FIN538S.(007 - 180).M

FEATURES

- Rated current from 7 to 180A
- Very high differential and common mode attenuation
- Low leakage current

BENEFITS

- 5 Year warranty
- Very high attenuation
- Easy installation

MARKETS

- Conveyors
- Testing equipment
- High tech machinery
- Automated machinery

ORDERING CODE

FIN538S .016 .M
 Model Current (A) Connection
 M = Terminal block

ATTENUATION INDICATOR

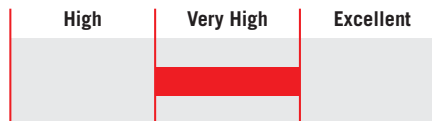

ELECTRIC DIAGRAM

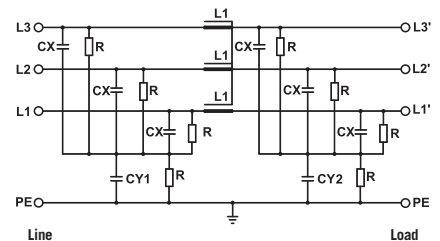

TECHNICAL SPECIFICATIONS

Nominal voltage	0 / 600 Vac
Frequency	50 – 60 Hz
Rated current	7 to 180A
Potential test voltage phase to phase	2400 Vdc (2 sec.)
Potential test voltage phase to ground	3200 Vdc (2 sec.)
Leakage current normal conditions	< 10 mA *
Leakage current worst conditions	< 80 mA
IP Protection	IP20
Overload capability	4 x Rated current (Switch ON) 2 x In 10 seconds 1.5 In for 10 minutes
Climatic class	-40 / +85° C
MTBF at 40°C	250.000 Hrs

* Voltage 230 Vac phase to ground 50 Hz / 40°C

ELECTRICAL CHARACTERISTICS

FIN538S	Rated Current 40°C	Rated Current 50°C	Power Loss (W)
.007.M	8	7	3
.016.M	18	16	4
.030.M	34	30	10
.042.M	47	42	18
.055.M	60	55	23
.075.M	83	75	37
.100.M	110	100	52
.130.M	142	130	65
.180.M	200	180	77

CONNECTIONS

LINE			PE	
Solid Cable (mm ²)	Stranded Cable (mm ²)	Terminal Torque (Nm)	d (mm)	Torque (Nm)
0.2 - 10	0.2 - 6	1.2	M6	1.2
0.2 - 10	0.2 - 6	1.2	M6	1.2
0.2 - 10	0.2 - 6	1.2	M6	1.2
0.5 - 16	0.5 - 10	1.8	M6	1.8
0.5 - 16	0.5 - 10	1.8	M6	1.8
4 - 25	6 - 35	4.5	M6	4.5
10 - 50	10 - 50	4	M10	4
10 - 50	10 - 50	4	M10	4
35 - 95	35 - 95	20	M10	20

TYPICAL ATTENUATION

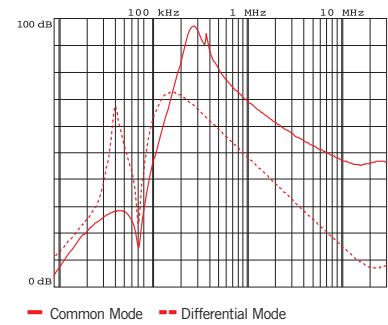

MECHANICAL DIMENSIONS mm

FIN538S	A	B	V	V1	F	H	I	L	N	d	Weight Kg.	Case
.007.M	100	90	22	16	5.4	250	220	7.5	60	M6	1.3	1
.016.M	100	90	22	16	5.4	250	220	7.5	60	M6	1.3	1
.030.M	100	90	22	16	5.4	250	220	7.5	60	M6	1.3	1
.042.M	100	90	22	35	5.4	250	220	7.5	60	M6	1.5	1
.055.M	100	90	22	35	5.4	250	220	7.5	60	M6	1.7	1
.075.M	135	85	22	39	6.5	270	240	7.5	60	M6	2.2	1
.100.M	155	90	24	43	6.5	270	240	7.5	60	M10	3.2	1
.130.M	155	90	24	43	6.5	270	240	7.5	60	M10	3.2	1
.180.M	170	125	26	51	6.5	380	350	7.5	102	M10	5.1	1

CASE 1

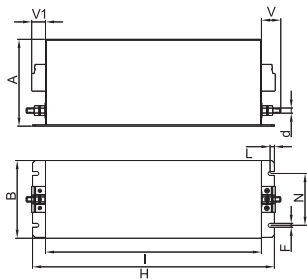

ASSEMBLY CONNECTION "M"

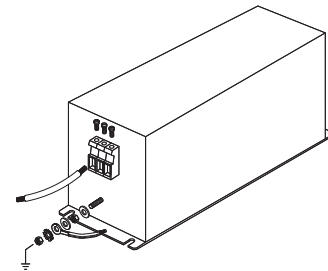



EMI/RFI Filter with excellent attenuation for industrial applications

Datasheet 3/2019

APPROVALS:



SCCR by UL508A



FIN538S1.(007 – 180).M



FIN538S1.(250 – 280).V



FIN538S1.(280 – 1750).BC

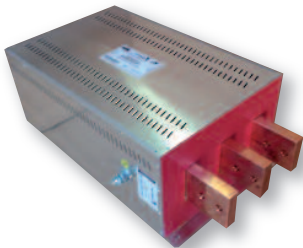

FIN538S1.(1750 – 3000).BC

FEATURES

- Rated current from 7 to 3000A
- Excellent differential and common mode attenuation
- Low leakage current
- Terminal blocks up to 180A

BENEFITS

- 5 Year warranty
- Various connections available
- Finger safe protection available
- Vertical bus bar available

MARKETS

- Electrical equipment
- Machine tools
- Industrial automation
- Frequency drives and servo drives
- Regenerative systems
- Renewable energy

ORDERING CODE

FIN538S1	.007	.M
Model	Current (A)	Connection
		M = Terminal block
		V = Screw
		BC = Bus bar

ATTENUATION INDICATOR

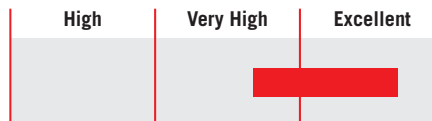

ELECTRIC DIAGRAM

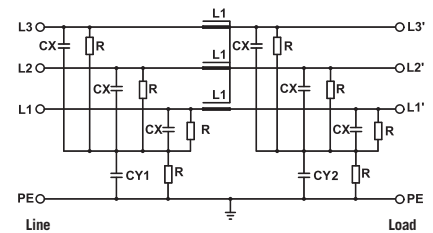

TECHNICAL SPECIFICATIONS

Nominal voltage	0 / 600 Vac
Frequency	50 – 60 Hz
Rated current	7 to 3000A
Potential test voltage phase to phase	2400 Vdc (2 sec.)
Potential test voltage phase to ground	3200 Vdc (2 sec.)
Leakage current normal conditions	< 10 mA *
Leakage current worst conditions	< 80 mA
IP Protection	IP20 up to 180A IP00 over 280A (IP 20 available with protection FINPRT)
Overload capability	4 x Rated current (Switch ON) 2 x In 10 seconds 1.5 In for 10 minutes
Climatic class	-40 / +85° C
MTBF at 40°C	250.000 Hrs

* Voltage 230 Vac phase to ground 50 Hz / 40°C

MECHANICAL DIMENSIONS mm

FIN538S1	A	B	V	V1	F	H	I	L	N	d	Weight Kg.	Case
.007.M	100	90	22	16	5.4	250	220	7.5	60	M6	1.3	1
.016.M	100	90	22	16	5.4	250	220	7.5	60	M6	1.3	1
.030.M	100	90	22	16	5.4	250	220	7.5	60	M6	1.3	1
.042.M	100	90	22	35	5.4	250	220	7.5	60	M6	1.5	2
.055.M	100	90	22	35	5.4	250	220	7.5	60	M6	1.5	2
.075.M	135	85	22	39	6.5	270	240	7.5	60	M6	2.2	3
.100.M	155	90	24	43	6.5	270	240	7.5	65	M10	3.2	4
.130.M	155	90	24	43	6.5	270	240	7.5	65	M10	3.2	4
.180.M	170	125	26	51	6.5	380	350	7.5	102	M10	5.5	5

CASE 1, 2, 3, 4, 5

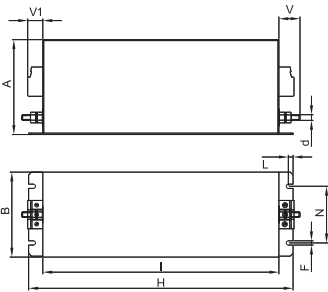

ASSEMBLY CONNECTION "M"

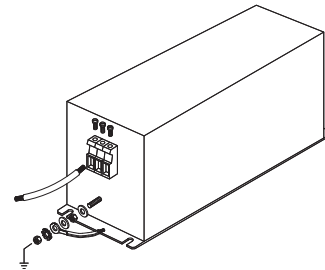

MECHANICAL DIMENSIONS mm

FIN538S1	A	B	C	d	d1	V	F	H	I	L	N	P	S	Weight Kg.	Case
.250.V	90	220	120	M12	M10	30	6.5	356	320	340	95	70	60	9	6
.280.V	90	220	120	M12	M10	30	6.5	356	320	340	95	70	60	9	6

CASE 6

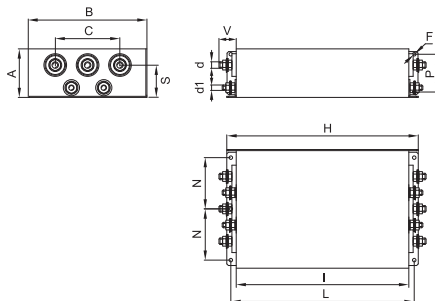

ASSEMBLY CONNECTION "V"

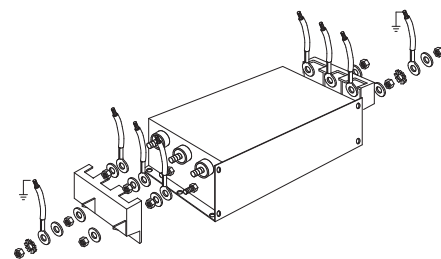

MECHANICAL DIMENSIONS mm

FIN538S1	A	B	C	d	d1	d2	d3	V	F	H	I	L	N	P	S	Weight Kg.	Case
.280.BC	90	220	120	M8	M10	6	20	42	6.5	356	320	340	95	70	55	9	7
.320.BC	90	220	120	M8	M10	6	20	42	6.5	356	320	340	95	70	55	9	7
.360.BC	130	230	150	M8	M10	10	25	42	6.5	420	380	400	100	100	85	13.5	8
.400.BC	130	230	150	M8	M10	10	25	42	6.5	420	380	400	100	100	85	13.5	8
.500.BC	130	230	150	M8	M10	10	25	42	6.5	420	380	400	100	100	85	13.5	8
.600.BC	130	230	150	M12	M10	15	30	48	6.5	510	450	480	100	100	85	19	9
.750.BC	130	230	150	M12	M10	15	30	48	6.5	510	450	480	100	100	85	19	9
.900.BC	160	250	140	M12	M12	20	40	94	8.5	510	450	480	100	110	110	27	10
.1000.BC	160	250	140	M12	M12	20	40	94	8.5	510	450	480	100	110	110	27	10
.1250.BC	160	250	140	M12	M12	20	40	94	8.5	510	450	480	100	110	110	27	10
.1500.BC	180	300	200	M12	M12	20	60	97	8.5	560	500	530	125	130	117	30	11
.1600.BC	180	300	200	M12	M12	20	60	97	8.5	560	500	530	125	130	117	30	11
.1750.BC	180	300	200	M12	M12	20	60	97	8.5	560	500	530	125	130	117	30	11
.2000.BC	225	350	200	M12	M12	25	80	100	8.5	610	550	580	150	-	113	68	12
.2250.BC	225	350	200	M12	M12	25	80	100	8.5	610	550	580	150	-	113	68	12
.2500.BC	225	350	200	M12	M12	25	80	100	8.5	610	550	580	150	-	113	68	12
.3000.BC	225	350	200	M12	M12	25	80	100	8.5	610	550	580	150	-	113	68	12

CASE 7, 8, 9

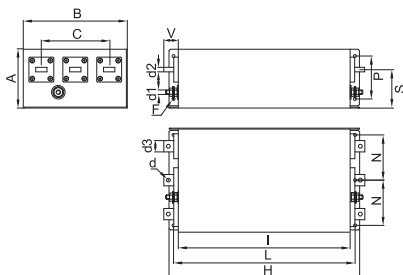

ASSEMBLY CONNECTION "BC"

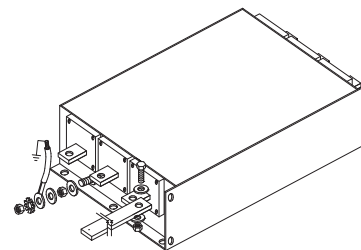

CASE 10, 11

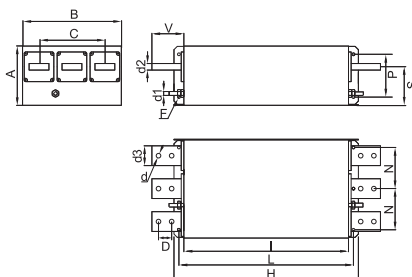

ASSEMBLY CONNECTION "BC"

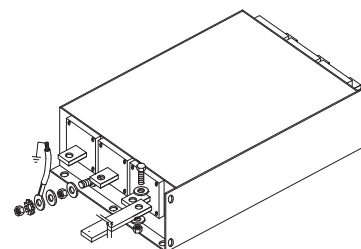

CASE 12

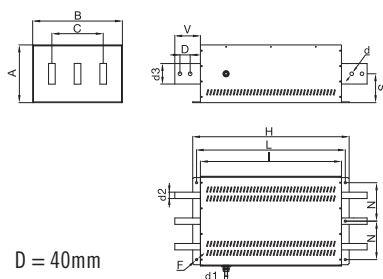

ASSEMBLY CONNECTION "BC"

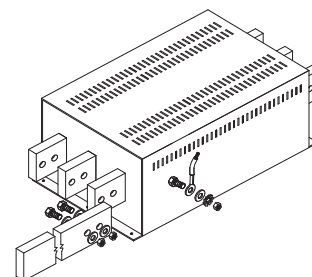



EMI/RFI Filter with very high attenuation for industrial applications

Datasheet 3/2019

APPROVALS:



FIN539S.(400 - 2500).B

FEATURES

- Rated current from 400 to 2500A
- Very high differential and common mode attenuation
- Low leakage current

BENEFITS

- 5 Year warranty
- Large bus bars allow ambient temperature of 70°C
- Compact design

MARKETS

- Renewable energy
- Uninterruptible power supplies
- Packaging machinery
- Process plants

ORDERING CODE

FIN539S .900 .M
 Model Current (A) Connection
 B = Bus bar

ATTENUATION INDICATOR

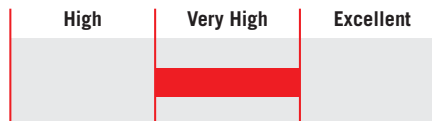

ELECTRIC DIAGRAM

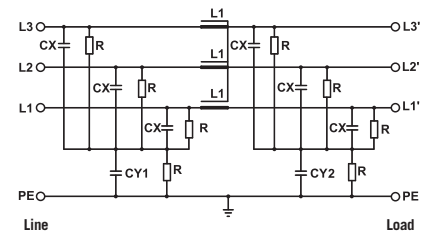

TECHNICAL SPECIFICATIONS

Nominal voltage	0 / 600 Vac
Frequency	50 – 60 Hz
Rated current	400 to 2500A
Potential test voltage phase to phase	2400 Vdc (2 sec.)
Potential test voltage phase to ground	3200 Vdc (2 sec.)
Leakage current normal conditions	< 10 mA *
Leakage current worst conditions	< 80 mA
IP Protection	IP00
Overload capability	IP 20 with FINPRT protection (optional)
	4 x Rated current (Switch ON)
	2 x In 10 seconds 1.5 In for 10 minutes
Climatic class	-40 / +85° C
MTBF at 40°C	250.000 Hrs

* Voltage 230 Vac phase to ground 50 Hz / 40°C

ELECTRICAL CHARACTERISTICS

FIN539S	Rated Current 40°C	Rated Current 50°C	Power Loss (W)
.400.B	420	400	92
.500.B	525	500	102
.600.B	630	600	82
.750.B	790	750	95
.900.B	945	900	105
.1000.B	1050	1000	92
.1250.B	1300	1300	98
.1500.B	1550	1500	108
.1750.B	1800	1750	105
.2000.B	2100	2000	92
.2250.B	2350	2250	98
.2500.B	2650	2500	108

CONNECTIONS

LINE		PE	
d (mm)	Torque (Nm)	d 1 (mm)	Torque (Nm)
M8	14	M10	18
M8	14	M10	18
M8	14	M10	18
M10	25	M10	18
M10	25	M10	18
M12	50	M12	20
M12	50	M12	20
M12	50	M12	20
M12	50	M12	20
M12	50	M12	20
M12	50	M12	20
M12	50	M12	20

TYPICAL ATTENUATION

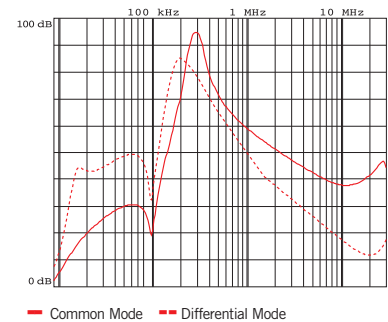

MECHANICAL DIMENSIONS mm

FIN539S	A	B	C	d	d1	d2	d3	V	F	H	I	L	N	P	S	Weight Kg.	Case
.400.B	130	230	150	M8	M10	10	25	42	6.5	420	380	400	100	100	85	13.5	1
.500.B	130	230	150	M8	M10	10	25	42	6.5	420	380	400	100	100	85	13.5	1
.600.B	130	230	150	M8	M10	15	30	48	6.5	510	450	480	100	100	85	19	2
.750.B	130	230	150	M10	M10	15	30	48	6.5	510	450	480	100	100	85	19	2
.900.B	130	230	150	M10	M10	15	30	48	6.5	510	450	480	100	100	85	19	2
.1000.B	160	250	140	M12	M12	20	40	94	8.5	510	450	480	100	110	110	27	3
.1250.B	160	250	140	M12	M12	20	40	94	8.5	510	450	480	100	110	110	27	3
.1500.B	160	250	140	M12	M12	20	40	94	8.5	510	450	480	100	110	110	27	3
.1750.B	180	350	200	M12	M12	20	60	97	8.5	610	550	580	150	130	117	32	4
.2000.B	180	350	200	M12	M12	20	60	97	8.5	610	550	580	150	130	117	32	4
.2250.B	180	350	200	M12	M12	20	60	97	8.5	610	550	580	150	130	117	32	4
.2500.B	180	350	200	M12	M12	20	60	97	8.5	610	550	580	150	130	117	32	4

CASE 1, 2, 3, 4

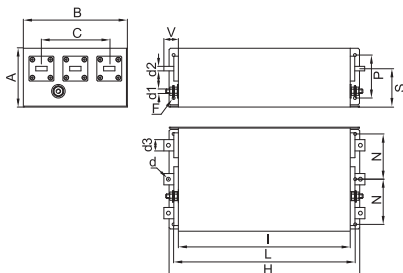

ASSEMBLY CONNECTION "B"

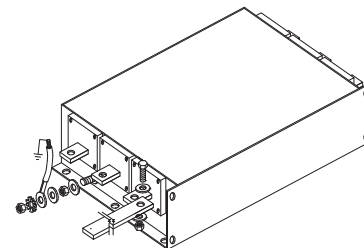



EMI/RFI Filter with excellent attenuation for industrial applications

Datasheet 3/2019

APPROVALS:

UL1283
CSA C22.2
E215863



SCCR by UL508A



FIN1200.(005 - 280).V

FEATURES

- Rated current from 5 to 3000A
- Excellent differential and common mode attenuation
- Very low leakage current

BENEFITS

- 5 Year warranty
- Various connections available
- Finger safe protection available
- Vertical bus bar available



FIN1200.(280 - 1750).BC

MARKETS

- Electrical equipment
- Semiconductor equipment
- Industrial automation
- Variable frequency drives / servo drives
- MRI - Medical equipment
- Renewable energy

ORDERING CODE

FIN1200(HV)	.100	.V
Model	Current (A)	Connection
HV = 600Vac		V = Screw
		BC = Bus bar

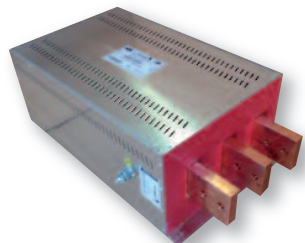

FIN1200.(2000 - 3000).BC

ATTENUATION INDICATOR

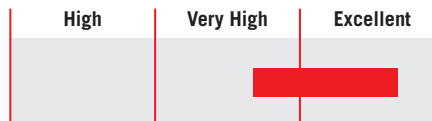

ELECTRIC DIAGRAM

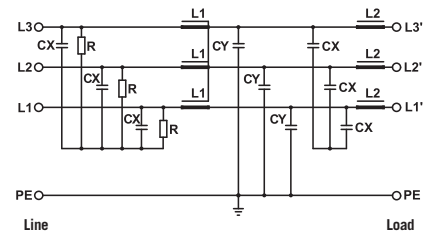

TECHNICAL SPECIFICATIONS

	FIN1200	FIN1200HV
Nominal voltage	0 / 480 Vac	0 / 600 Vac
Frequency	50 – 60 Hz	
Rated current	5 to 3000A	
Potential test voltage phase to phase	2200 Vdc (2 sec.)	2400 Vdc (2 sec.)
Potential test voltage phase to ground	2900 Vdc (2 sec.)	3200 Vdc (2 sec.)
Leakage current normal conditions	< 3 mA *	
Leakage current worst conditions	< 10 mA	
IP Protection	IP20 up to 280A IP00 over 280A (IP 20 available with protection FINPRT)	
Overload capability	4 x Rated current (Switch ON) 2 x In 10 seconds 1.5 In for 10 minutes	
Climatic class	-40 / +85° C	
MTBF at 40°C	250.000 Hrs	

* Voltage 230 Vac phase to ground 50Hz / 40°C

FIN1200HV AVAILABLE UP TO 750Vac

ELECTRICAL CHARACTERISTICS

FIN1200 FIN1200HV	Rated Current 40°C	Rated Current 50°C	Power Loss (W)
.005.V	5	4	5
.010.V	10	8	7
.016.V	16	14	14
.030.V	30	27	11
.050.V	50	46	10
.080.V	80	75	35
.100.V	100	90	42
.150.V	150	140	74
.200.V	200	190	90
.250.V	272	250	90
.280.V	290	280	80
.280.BC	297	280	78
.320.BC	330	320	80
.360.BC	390	360	105
.400.BC	435	400	110
.500.BC	545	500	102
.600.BC	654	600	108
.750.BC	800	750	96
.900.BC	940	900	80
.1000.BC	1050	1000	115
.1250.BC	1290	1250	101
.1500.BC	1550	1500	120
.1600.BC	1650	1600	130
.1750.BC	1800	1750	135
.2000.BC	2050	2000	138
.2250.BC	2300	2250	145
.2500.BC	2550	2500	170
.3000.BC	3000	2950	180

CONNECTIONS

LINE		PE	
d (mm)	Torque (Nm)	d1 (mm)	Torque (Nm)
M4	1.2	M4	1.2
M4	1.2	M4	1.2
M5	4	M5	4
M5	4	M5	4
M6	6	M5	4
M8	14	M8	14
M8	14	M8	14
M10	18	M10	18
M10	18	M10	18
M12	20	M10	18
M12	20	M10	18
M8	14	M10	18
M8	14	M10	18
M8	14	M10	18
M8	14	M10	18
M10	25	M10	18
M10	25	M10	18
M12	50	M12	20
M12	50	M12	20
M12	50	M12	20
M12	50	M12	20
M12	50	M12	20
M12	50	M12	20
M12	50	M12	20
M12	50	M12	20
M12	50	M12	20
M12	50	M12	20

TYPICAL ATTENUATION

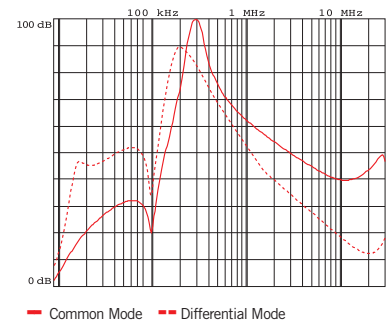

Typical attenuation 5A – 400A

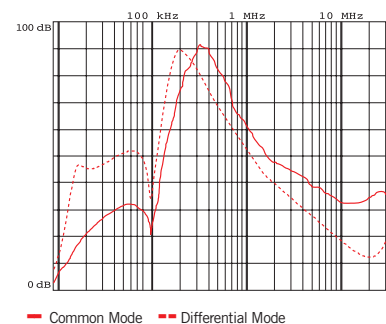

Typical attenuation 500A – 3000A

MECHANICAL DIMENSIONS mm

FIN1200 FIN1200HV	A	B	C	d	d1	V	F	H	I	L	N	P	S	Weight Kg.	Case
.005.V	58	86	44	M4	M4	14	4.5	186	160	176	30	40	38	2	1
.010.V	58	86	44	M4	M4	14	4.5	186	160	176	30	40	38	2	1
.016.V	90	100	46	M5	M5	28	4.5	246	220	235	35	70	64	3	2
.030.V	90	100	46	M5	M5	28	4.5	246	220	235	35	70	64	3	2
.050.V	90	100	46	M6	M5	28	4.5	246	220	235	35	70	64	3	3
.080.V	90	185	84	M8	M8	25	6.5	356	320	340	77.5	70	69	5	4
.100.V	90	185	84	M8	M8	25	6.5	356	320	340	77.5	70	69	5	4
.150.V	90	220	120	M10	M10	29	6.5	356	320	340	95	70	60	7	5
.200.V	90	220	120	M10	M10	29	6.5	356	320	340	95	70	60	7	5
.250.V	90	220	120	M12	M10	30	6.5	356	320	340	95	70	60	9	6
.280.V	90	220	120	M12	M10	30	6.5	356	320	340	95	70	60	9	6

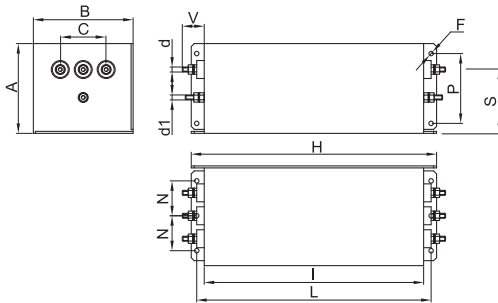
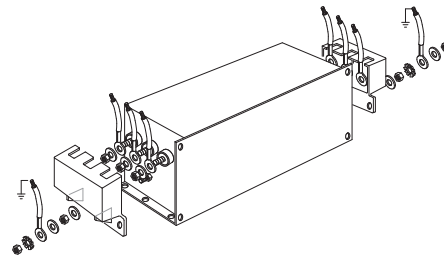
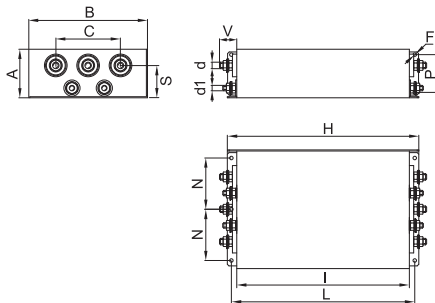
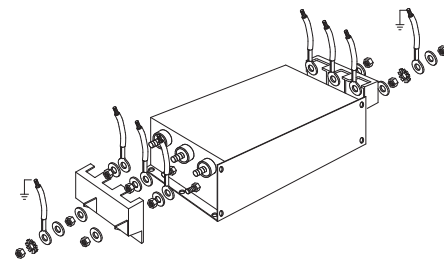
CASE 1, 2, 3, 4

ASSEMBLY CONNECTION "V"

CASE 5, 6

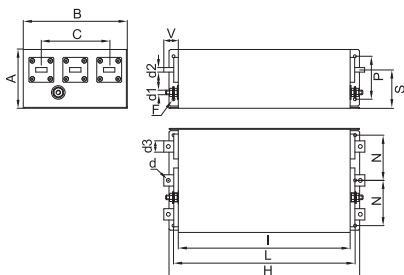
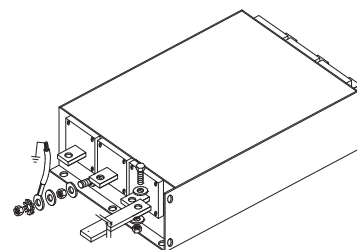
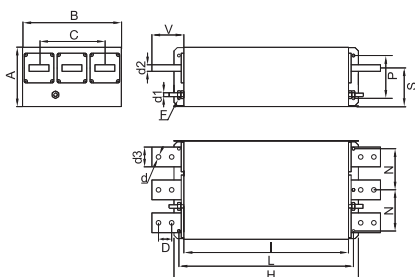
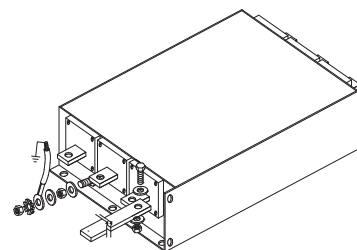
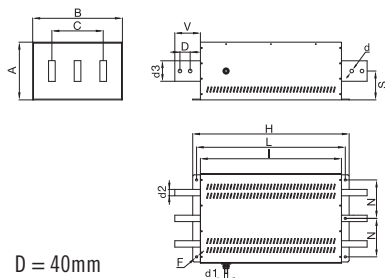
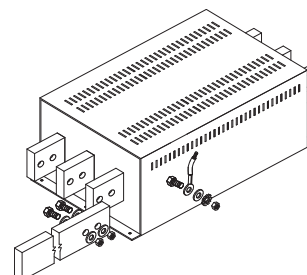
ASSEMBLY CONNECTION "V"

MECHANICAL DIMENSIONS mm

FIN1200 FIN1200HV	A	B	C	d	d1	d2	d3	V	F	H	I	L	N	P	S	Weight Kg.	Case
.280.BC	90	220	120	M8	M10	6	20	42	6.5	356	320	340	95	70	55	9	7
.320.BC	90	220	120	M8	M10	6	20	42	6.5	356	320	340	95	70	55	9	7
.360.BC	130	230	150	M8	M10	10	25	42	6.5	420	380	400	100	100	85	13.5	8
.400.BC	130	230	150	M8	M10	10	25	42	6.5	420	380	400	100	100	85	13.5	8
.500.BC	130	230	150	M8	M10	10	25	42	6.5	420	380	400	100	100	85	13.5	8
.600.BC	130	230	150	M12	M10	15	30	48	6.5	510	450	480	100	100	85	19	9
.750.BC	130	230	150	M12	M10	15	30	48	6.5	510	450	480	100	100	85	19	9
.900.BC	160	250	140	M12	M12	20	40	94	8.5	510	450	480	100	110	110	27	10
.1000.BC	160	250	140	M12	M12	20	40	94	8.5	510	450	480	100	110	110	27	10
.1250.BC	160	250	140	M12	M12	20	40	94	8.5	510	450	480	100	110	110	27	10
.1500.BC	180	300	200	M12	M12	20	60	97	8.5	560	500	530	125	130	117	30	11
.1600.BC	180	300	200	M12	M12	20	60	97	8.5	560	500	530	125	130	117	30	11
.1750.BC	180	300	200	M12	M12	20	60	97	8.5	560	500	530	125	130	117	30	11
.2000.BC	225	350	200	M12	M12	25	80	100	8.5	610	550	580	150	-	113	68	12
.2250.BC	225	350	200	M12	M12	25	80	100	8.5	610	550	580	150	-	113	68	12
.2500.BC	225	350	200	M12	M12	25	80	100	8.5	610	550	580	150	-	113	68	12
.3000.BC	225	350	200	M12	M12	25	80	100	8.5	610	550	580	150	-	113	68	12

CASE 7, 8, 9

ASSEMBLY CONNECTION "BC"

CASE 10, 11

ASSEMBLY CONNECTION "BC"

CASE 12

ASSEMBLY CONNECTION "BC"



EMI/RFI Filter with excellent attenuation for industrial applications

Datasheet 3/2019

APPROVALS:

UL1283
CSA C22.2
E215863



SCCR by UL508A



FIN1500.(005 – 280).V

FEATURES

- Rated current from 5 to 3000A
- Excellent differential and common mode attenuation
- Low leakage current

BENEFITS

- 5 Year warranty
- Various connections
- Finger safe protection available
- Vertical bus bar available



FIN1500.(280 – 1750).BC

MARKETS

- Electrical equipment
- Machine tools
- Industrial automation
- Variable frequency drives / servo drives
- Regenerative system
- Renewable energy

ORDERING CODE

FIN1500(HV) .100 .V
 Model Current (A) Connection
 HV = 600Vac V = Screw
 BC = Bus bar

ATTENUATION INDICATOR

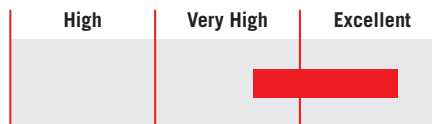

ELECTRIC DIAGRAM

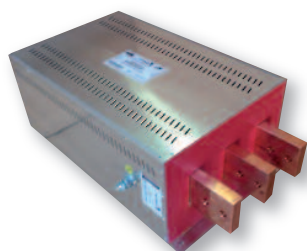
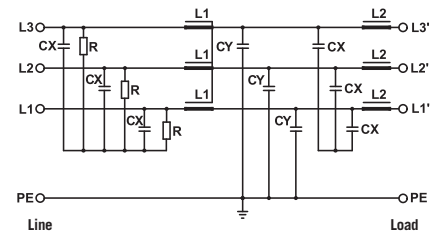

FIN1500.(1750 – 3000).BC

TECHNICAL SPECIFICATIONS

	FIN1500	FIN1500HV
Nominal voltage	0 / 480 Vac	0 / 600 Vac
Frequency	50 – 60 Hz	
Rated current	5 to 3000A	
Potential test voltage phase to phase	2200 Vdc (2 sec.)	2400 Vdc (2 sec.)
Potential test voltage phase to ground	2900 Vdc (2 sec.)	3200 Vdc (2 sec.)
Leakage current normal conditions	<10 mA*	
Leakage current worst conditions	<35 mA	
IP Protection	IP20 up to 280A IP00 over 280A (IP 20 available with protection FINPRT)	
Overload capability	4 x Rated current (Switch ON) 2 x In 10 seconds 1.5 In for 10 minutes	
Climatic class	-40 / +85° C	
MTBF at 40°C	250.000 Hrs	

* Voltage 230 Vac phase to ground 50Hz / 40°C

MECHANICAL DIMENSIONS mm

FIN1500 FIN1500HV	A	B	C	d	d1	V	F	H	I	L	N	P	S	Weight Kg.	Case
.005.V	58	86	44	M4	M4	14	4.5	186	160	176	30	40	38	2	1
.010.V	58	86	44	M4	M4	14	4.5	186	160	176	30	40	38	2	1
.016.V	90	100	46	M5	M5	28	4.5	246	220	235	35	70	64	3	2
.030.V	90	100	46	M5	M5	28	4.5	246	220	235	35	70	64	3	2
.050.V	90	100	46	M6	M5	28	4.5	246	220	235	35	70	64	3	3
.080.V	90	185	84	M8	M8	25	6.5	356	320	340	77.5	70	69	5	4
.100.V	90	185	84	M8	M8	25	6.5	356	320	340	77.5	70	69	5	4
.150.V	90	220	120	M10	M10	29	6.5	356	320	340	95	70	60	7	5
.200.V	90	220	120	M10	M10	29	6.5	356	320	340	95	70	60	7	5
.250.V	90	220	120	M12	M10	30	6.5	356	320	340	95	70	60	9	6
.280.V	90	220	120	M12	M10	30	6.5	356	320	340	95	70	60	9	6

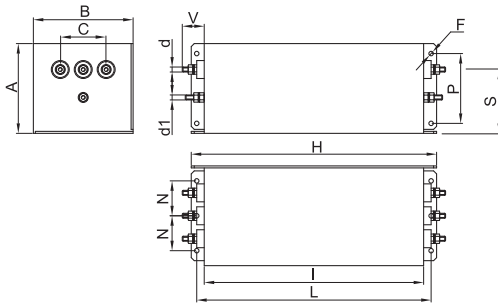
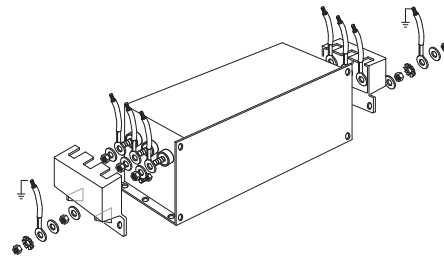
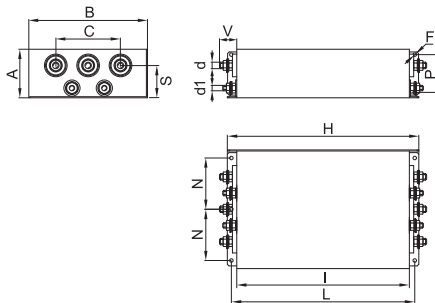
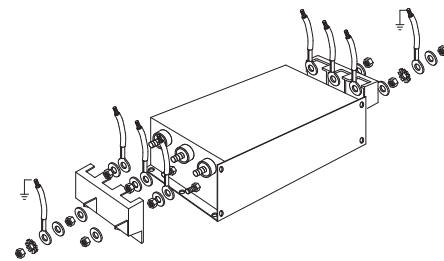
CASE 1, 2, 3, 4

ASSEMBLY CONNECTION "V"

CASE 5, 6

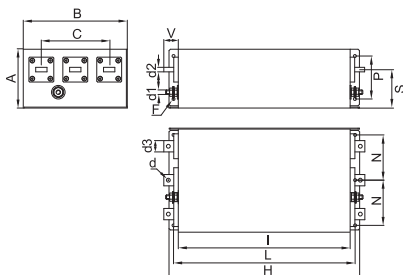
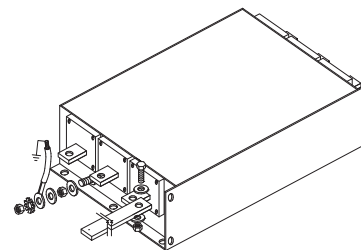
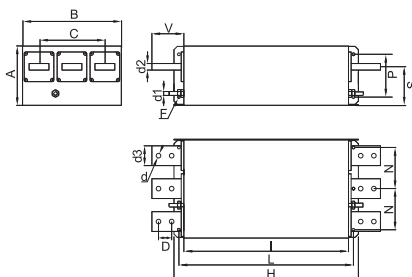
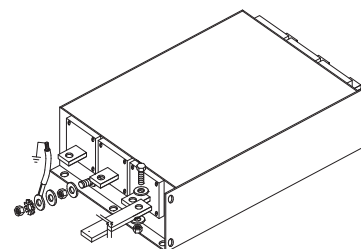
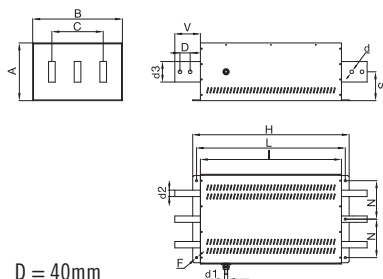
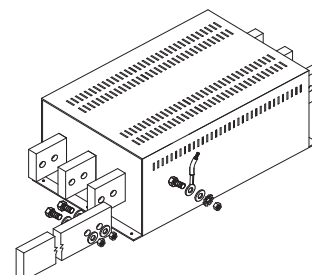
ASSEMBLY CONNECTION "V"

MECHANICAL DIMENSIONS mm

FIN1500 FIN1500HV	A	B	C	d	d1	d2	d3	V	F	H	I	L	N	P	S	Weight Kg.	Case
.280.BC	90	220	120	M8	M10	6	20	42	6.5	356	320	340	95	70	55	9	7
.320.BC	90	220	120	M8	M10	6	20	42	6.5	356	320	340	95	70	55	9	7
.360.BC	130	230	150	M8	M10	10	25	42	6.5	420	380	400	100	100	85	13.5	8
.400.BC	130	230	150	M8	M10	10	25	42	6.5	420	380	400	100	100	85	13.5	8
.500.BC	130	230	150	M8	M10	10	25	42	6.5	420	380	400	100	100	85	13.5	8
.600.BC	130	230	150	M12	M10	15	30	48	6.5	510	450	480	100	100	85	19	9
.750.BC	130	230	150	M12	M10	15	30	48	6.5	510	450	480	100	100	85	19	9
.900.BC	160	250	140	M12	M12	20	40	94	8.5	510	450	480	100	110	110	27	10
.1000.BC	160	250	140	M12	M12	20	40	94	8.5	510	450	480	100	110	110	27	10
.1250.BC	160	250	140	M12	M12	20	40	94	8.5	510	450	480	100	110	110	27	10
.1500.BC	180	300	200	M12	M12	20	60	97	8.5	560	500	530	125	130	117	30	11
.1600.BC	180	300	200	M12	M12	20	60	97	8.5	560	500	530	125	130	117	30	11
.1750.BC	180	300	200	M12	M12	20	60	97	8.5	560	500	530	125	130	117	30	11
.2000.BC	225	350	200	M12	M12	25	80	100	8.5	610	550	580	150	-	113	68	12
.2250.BC	225	350	200	M12	M12	25	80	100	8.5	610	550	580	150	-	113	68	12
.2500.BC	225	350	200	M12	M12	25	80	100	8.5	610	550	580	150	-	113	68	12
.3000.BC	225	350	200	M12	M12	25	80	100	8.5	610	550	580	150	-	113	68	12

CASE 7, 8, 9

ASSEMBLY CONNECTION "BC"

CASE 10, 11

ASSEMBLY CONNECTION "BC"

CASE 12

ASSEMBLY CONNECTION "BC"



EMI/RFI Filter with very high attenuation for industrial applications

Datasheet 3/2019

APPROVALS:



FIN1600.(007 – 200).M

FEATURES

- Rated current from 7 to 200A
- Very high differential and common mode attenuation

BENEFITS

- 5 Year warranty
- Safety terminal block connector
- Compact design

MARKETS

- Elevators
- Processing machinery
- Regeneration systems
- Uninterruptible power supplies

ORDERING CODE

FIN1600 .055 .M
 Model Current (A) Connection
 M = Terminal block

ATTENUATION INDICATOR

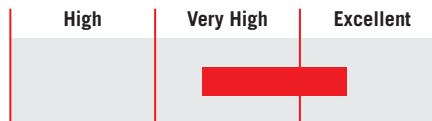

ELECTRIC DIAGRAM

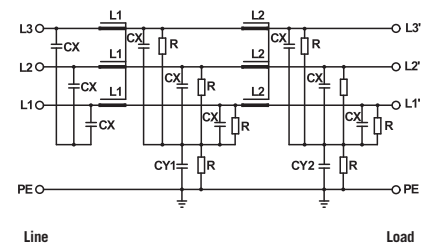

TECHNICAL SPECIFICATIONS

Nominal voltage	0 / 480 Vac
Frequency	50 – 60 Hz
Rated current	7 to 200A
Potential test voltage phase to phase	2200 Vdc (2 sec.)
Potential test voltage phase to ground	2900 Vdc (2 sec.)
Leakage current normal conditions	< 10 mA *
Leakage current worst conditions	< 130 mA
IP Protection	IP20
Overload capability	4 x Rated current (Switch ON) 2 x In 10 seconds 1.5 In for 10 minutes
Climatic class	-40 / +85° C
MTBF at 40°C	250.000 Hrs

* Voltage 230 Vac phase to ground 50 Hz / 40°C

ELECTRICAL CHARACTERISTICS

FIN1600	Rated Current 40°C	Rated Current 50°C	Power Loss (W)
.007.M	7	5	6
.013.M	13	11	10
.018.M	18	16	12
.034.M	34	30	24
.055.M	55	50	27
.090.M	90	80	37
.110.M	110	100	67
.160.M	160	150	100
.200.M	200	180	93

CONNECTIONS

LINE			PE	
Solid Cable (mm ²)	Stranded Cable (mm ²)	Terminal Torque (Nm)	d (mm)	Torque (Nm)
0.2 - 6	0.2 - 4	0.5	M5	0.5
0.2 - 6	0.2 - 4	0.5	M5	0.5
0.2 - 6	0.2 - 4	0.5	M5	0.5
0.2 - 10	0.2 - 6	1.2	M5	1.2
0.5 - 16	0.5 - 10	1.8	M6	1.8
4 - 25	6 - 35	4.5	M6	4.5
10 - 50	10 - 50	4	M10	4
10 - 50	10 - 50	4	M10	4
35 - 95	35 - 95	20	M10	20

TYPICAL ATTENUATION

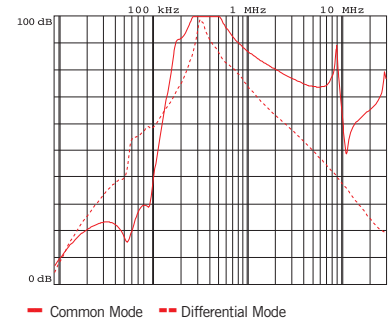

MECHANICAL DIMENSIONS mm

FIN1600	A	B	V	V1	F	H	I	L	N	d	Weight Kg.	Case
.007.M	126	50	19	11	6.5	255	225	7.5	25	M5	1.6	1
.013.M	126	50	19	11	6.5	255	225	7.5	25	M5	1.6	1
.018.M	143	55	19	11	6.5	305	276	7.5	30	M5	2.2	1
.034.M	150	60	19	16	6.5	335	305	7.5	35	M5	2.7	1
.055.M	185	70	18	33	6.5	329	300	7.5	45	M6	4.7	1
.090.M	220	80	18	39	6.5	329	300	7.5	55	M6	5.5	1
.110.M	220	90	28	43	6.5	379	350	7.5	65	M10	7.7	1
.160.M	240	110	28	43	6.5	439	400	12.5	65	M10	11	1
.200.M	240	110	28	50	6.5	439	400	12.5	65	M10	12	1

CASE 1

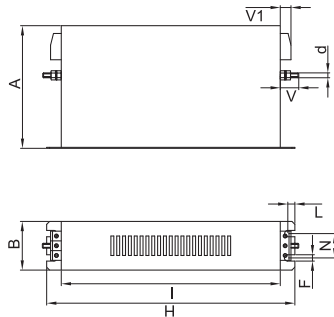

ASSEMBLY CONNECTION "M"

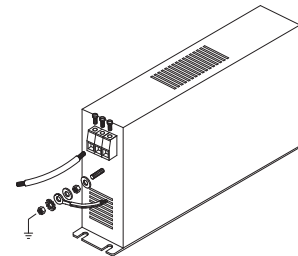



EMI/RFI Filter with very high attenuation for industrial applications

Datasheet 3/2019

APPROVALS:

UL1283
CSA C22.2
E215863



SCCR by UL508A



FIN1700.(006 - 200).M

FEATURES

- Rated current from 6 to 200A
- Very high differential and common mode attenuation
- Very low leakage current

BENEFITS

- 5 Year warranty
- Safety terminal block connector
- Helps pass immunity and emission tests for the IEC61000-6-2 and IEC61000-6-4 Standards

MARKETS

- Food industry
- Woodworking machinery
- Packaging machinery
- Printing machinery

ORDERING CODE

FIN1700 .055 .M
Model Current (A) Connection
M = Terminal block

ATTENUATION INDICATOR

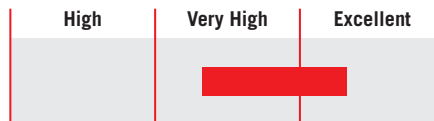

ELECTRIC DIAGRAM

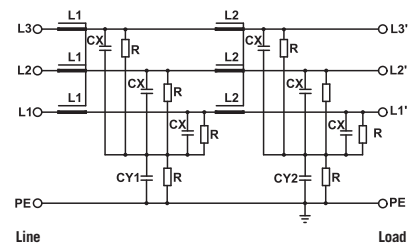

TECHNICAL SPECIFICATIONS

Nominal voltage	0 / 600 Vac
Frequency	50 – 60 Hz
Rated current	6 to 200A
Potential test voltage phase to phase	2400 Vdc (2 sec.)
Potential test voltage phase to ground	3200 Vdc (2 sec.)
Leakage current normal conditions	< 3 mA *
Leakage current worst conditions	< 15 mA
IP Protection	IP20
Overload capability	4 x Rated current (Switch ON) 2 x In 10 seconds 1.5 In for 10 minutes
Climatic class	-40 / +85° C
MTBF at 40°C	250.000 Hrs

* Voltage 230 Vac phase to ground 50 Hz / 40°C

ELECTRICAL CHARACTERISTICS

FIN1700	Rated Current 40°C	Rated Current 50°C	Power Loss (W)
.006.M	8	6	8
.012.M	14	12	10
.016.M	18	16	12
.025.M	28	25	15
.032.M	35	32	23
.042.M	50	42	32
.055.M	63	55	37
.070.M	80	70	52
.080.M	90	80	60
.100.M	110	100	92
.115.M	130	115	101
.150.M	175	150	115
.200.M	230	200	120

CONNECTIONS

LINE			PE	
Solid Cable (mm ²)	Stranded Cable (mm ²)	Terminal Torque (Nm)	d (mm)	Torque (Nm)
0.2 - 10	0.2 - 6	1.2	M6	6
0.2 - 10	0.2 - 6	1.2	M6	6
0.2 - 10	0.2 - 6	1.2	M6	6
0.2 - 10	0.2 - 6	1.2	M6	6
0.2 - 10	0.2 - 6	1.2	M6	6
0.5 - 16	0.5 - 10	1.8	M6	6
0.5 - 16	0.5 - 10	1.8	M6	6
4 - 25	6 - 35	4.5	M10	18
4 - 25	6 - 35	4.5	M10	18
10 - 50	10 - 50	4	M10	18
10 - 50	10 - 50	4	M10	18
35 - 95	35 - 95	20	M10	18
35 - 95	35 - 95	20	M10	18

TYPICAL ATTENUATION

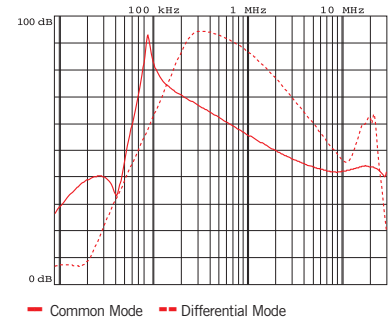

MECHANICAL DIMENSIONS mm

FIN1700	A	B	V	V1	F	H	I	L	N	d	Weight Kg.	Case
.006.M	140	50	19	15	6	226	200	7	28	M6	1.7	1
.012.M	140	50	19	15	6	226	200	7	28	M6	1.7	1
.016.M	177	60	19	15	6	267	237	8	34	M6	1.7	1
.025.M	177	60	19	15	6	267	237	8	34	M6	2.3	1
.032.M	177	60	19	15	6	267	237	8	34	M6	2.3	1
.042.M	177	70	19	25	6	295	265	8	44	M6	3.4	1
.055.M	177	70	19	33	6	295	265	8	44	M6	3.5	1
.070.M	205	80	28	38	8	390	340	12	53	M10	6	1
.080.M	205	80	28	38	8	390	340	12	53	M10	6	1
.100.M	205	80	28	43	8	390	340	12	53	M10	7.1	1
.115.M	205	80	28	43	8	390	340	12	53	M10	7.1	1
.150.M	220	105	28	50	8	420	370	12	78	M10	8.5	1
.200.M	220	105	28	50	8	420	370	12	78	M10	8.5	1

CASE 1

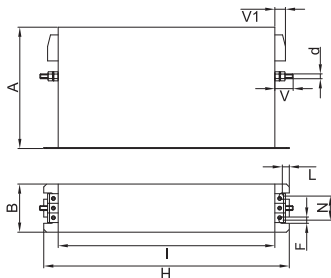

ASSEMBLY CONNECTION "M"

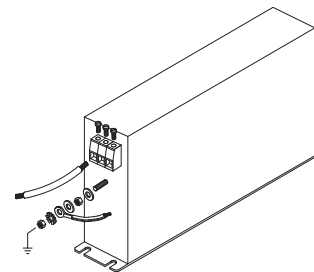



EMI/RFI Filter with very high attenuation for industrial applications

Datasheet 3/2019



FIN1700G.(006 - 200).M

FEATURES

- Rated current from 6 to 200A
- Very high differential and common mode attenuation
- Very low leakage current
- High attenuation in the low frequency range 100 kHz – 2 MHz

MARKETS

- Food industry
- Woodworking machinery
- Packaging machinery
- Printing machinery

APPROVALS:

UL1283
CSA C22.2
E215863



SCCR by UL508A

BENEFITS

- 5 Year warranty
- Safety terminal block connector
- Helps pass immunity and emission tests for the IEC61000-6-2 and IEC61000-6-4 Standards

ORDERING CODE

FIN1700G .055 .M
Model Current (A) Connection
M = Terminal block

ATTENUATION INDICATOR

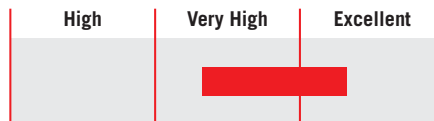

ELECTRIC DIAGRAM

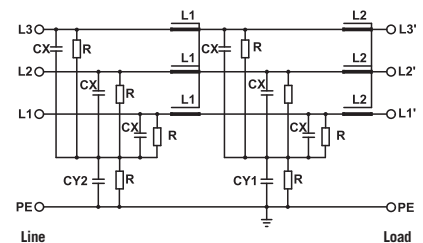

TECHNICAL SPECIFICATIONS

Nominal voltage	0 / 600 Vac
Frequency	50 – 60 Hz
Rated current	6 to 200A
Potential test voltage phase to phase	2400 Vdc (2 sec.)
Potential test voltage phase to ground	3200 Vdc (2 sec.)
Leakage current normal conditions	< 3 mA *
Leakage current worst conditions	< 15 mA
IP Protection	IP20
Overload capability	4 x Rated current (Switch ON) 2 x In 10 seconds 1.5 In for 10 minutes
Climatic class	-40 / +85° C
MTBF at 40°C	250.000 Hrs

* Voltage 230 Vac phase to ground 50 Hz / 40°C

ELECTRICAL CHARACTERISTICS

FIN1700G	Rated Current 40°C	Rated Current 50°C	Power Loss (W)
.006.M	8	6	8
.012.M	14	12	10
.016.M	18	16	12
.025.M	28	25	15
.032.M	35	32	23
.042.M	50	42	32
.055.M	63	55	37
.070.M	80	70	52
.080.M	90	80	60
.100.M	110	100	92
.115.M	130	115	101
.150.M	175	150	115
.200.M	230	200	120

CONNECTIONS

LINE			PE	
Solid Cable (mm ²)	Stranded Cable (mm ²)	Terminal Torque (Nm)	d (mm)	Torque (Nm)
0.2 - 10	0.2 - 6	1.2	M6	6
0.2 - 10	0.2 - 6	1.2	M6	6
0.2 - 10	0.2 - 6	1.2	M6	6
0.2 - 10	0.2 - 6	1.2	M6	6
0.2 - 10	0.2 - 6	1.2	M6	6
0.5 - 16	0.5 - 10	1.8	M6	6
0.5 - 16	0.5 - 10	1.8	M6	6
4 - 25	6 - 35	4.5	M10	18
4 - 25	6 - 35	4.5	M10	18
10 - 50	10 - 50	4	M10	18
10 - 50	10 - 50	4	M10	18
35 - 95	35 - 95	20	M10	18
35 - 95	35 - 95	20	M10	18

TYPICAL ATTENUATION

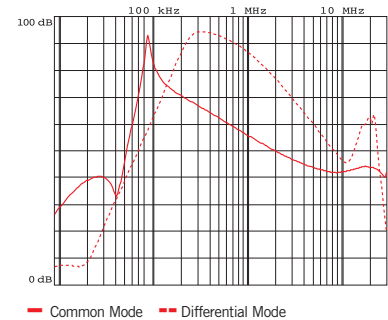

MECHANICAL DIMENSIONS mm

FIN1700G	A	B	V	V1	F	H	I	L	N	d	Weight Kg.	Case
.006.M	140	50	19	15	6	226	200	7	28	M6	1.7	1
.012.M	140	50	19	15	6	226	200	7	28	M6	1.7	1
.016.M	177	60	19	15	6	267	237	8	34	M6	1.7	1
.025.M	177	60	19	15	6	267	237	8	34	M6	2.3	1
.032.M	177	60	19	15	6	267	237	8	34	M6	2.3	1
.042.M	177	70	19	25	6	295	265	8	44	M6	3.4	1
.055.M	177	70	19	33	6	295	265	8	44	M6	3.5	1
.070.M	205	80	28	38	8	390	340	12	53	M10	6	1
.080.M	205	80	28	38	8	390	340	12	53	M10	6	1
.100.M	205	80	28	43	8	390	340	12	53	M10	7.1	1
.115.M	205	80	28	43	8	390	340	12	53	M10	7.1	1
.150.M	220	105	28	50	8	420	370	12	78	M10	8.5	1
.200.M	220	105	28	50	8	420	370	12	78	M10	8.5	1

CASE 1

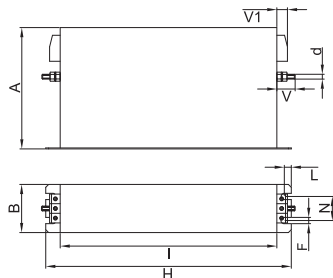

ASSEMBLY CONNECTION "M"

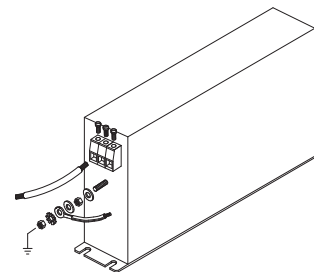



EMI/RFI Filter with very high attenuation for industrial applications

Datasheet 3/2019



FIN1700E.(007 - 230).M

FEATURES

- Rated current from 7 to 230A
- Very high differential and common mode attenuation
- Very low leakage current

MARKETS

- Packaging machinery
- Printing machinery
- Variable frequency drives / servo drives
- Medical equipment

APPROVALS:



SCCR by UL508A

BENEFITS

- 5 Year warranty
- Safety terminal block connector
- Very compact design

ORDERING CODE

FIN1700E .070 .M
 Model Current (A) Connection
 M = Terminal block

ATTENUATION INDICATOR

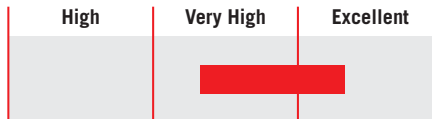

ELECTRIC DIAGRAM

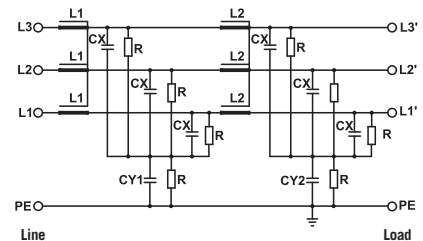

TECHNICAL SPECIFICATIONS

Nominal voltage	0 / 500 Vac
Frequency	50 – 60 Hz
Rated current	7 to 230A
Potential test voltage phase to phase	2300 Vdc (2 sec.)
Potential test voltage phase to ground	3100 Vdc (2 sec.)
Leakage current normal conditions	< 3 mA *
Leakage current worst conditions	< 15 mA
IP Protection	IP20
Overload capability	4 x Rated current (Switch ON) 2 x In 10 seconds 1.5 In for 10 minutes
Climatic class	-40 / +85° C
MTBF at 40°C	250.000 Hrs

* Voltage 230 Vac phase to ground 50 Hz / 40°C

ELECTRICAL CHARACTERISTICS

FIN1700E	Rated Current 40°C	Rated Current 50°C	Power Loss (W)
.007.M	7	6	8
.013.M	13	12	12
.018.M	18	16	15
.027.M	27	25	20
.034.M	34	32	32
.040.M	40	36	23
.055.M	55	50	42
.070.M	70	64	55
.100.M	100	90	60
.110.M	110	100	90
.130.M	130	120	98
.150.M	150	135	103
.200.M	200	180	115
.230.M	230	210	120

CONNECTIONS

LINE			PE	
Solid Cable (mm ²)	Stranded Cable (mm ²)	Terminal Torque (Nm)	d (mm)	Torque (Nm)
0.2 - 10	0.2 - 6	1.2	M6	6
0.2 - 10	0.2 - 6	1.2	M6	6
0.2 - 10	0.2 - 6	1.2	M6	6
0.2 - 10	0.2 - 6	1.2	M6	6
0.2 - 10	0.2 - 6	1.2	M6	6
0.2 - 10	0.2 - 6	1.2	M6	6
0.5 - 16	0.5 - 10	1.8	M6	6
0.5 - 16	0.5 - 10	1.8	M6	6
4 - 25	6 - 35	4.5	M10	18
4 - 25	6 - 35	4.5	M10	18
10 - 50	10 - 50	4	M10	18
10 - 50	10 - 50	4	M10	18
35 - 95	35 - 95	20	M10	18
35 - 95	35 - 95	20	M10	18

TYPICAL ATTENUATION

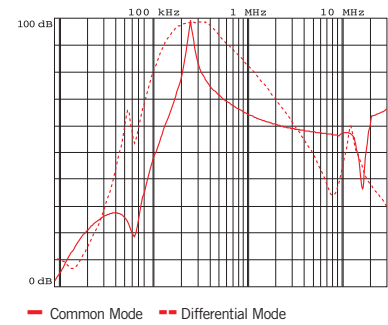

MECHANICAL DIMENSIONS mm

FIN1700E	A	B	V	V1	F	H	I	L	N	d	Weight Kg.	Case
.007.M	140	50	19	15	6	226	200	7	28	M6	1.7	1
.013.M	140	50	19	15	6	226	200	7	28	M6	1.7	1
.018.M	140	50	19	15	6	226	200	7	28	M6	1.7	1
.027.M	140	50	19	15	6	226	200	7	28	M6	1.7	1
.034.M	140	50	19	15	6	226	200	7	28	M6	1.7	1
.040.M	140	50	19	15	6	226	200	7	28	M6	1.7	1
.055.M	177	70	19	25	6	295	265	8	44	M6	3.7	1
.070.M	177	70	19	33	6	295	265	8	44	M6	5.2	1
.100.M	205	80	28.5	38	8	390	340	12	53	M10	6.5	1
.110.M	205	80	28.5	38	8	390	340	12	53	M10	6.5	1
.130.M	205	80	28.5	43	8	390	340	12	53	M10	7.1	1
.150.M	205	80	28.5	43	8	390	340	12	53	M10	7.1	1
.200.M	220	105	28.5	50	8	420	370	12	78	M10	8	1
.230.M	220	105	28.5	50	8	420	370	12	78	M10	8	1

CASE 1

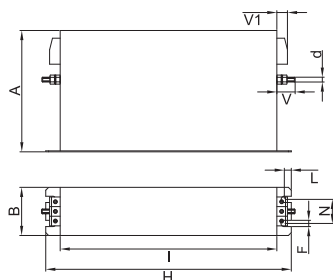

ASSEMBLY CONNECTION "M"

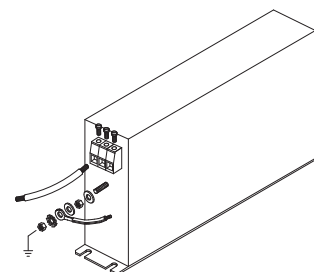



EMI/RFI Filter with very high attenuation for industrial applications

Datasheet 3/2019



FIN1700EG.(007 – 230).M

FEATURES

- Rated current from 7 to 230A
- Very high differential and common mode attenuation
- Very low leakage current
- High attenuation in the low frequency range 100 kHz – 2 MHz

MARKETS

- Packaging machinery
- Printing machinery
- Variable frequency drives / servo drives
- Medical equipment

APPROVALS:



SCCR by UL508A

BENEFITS

- 5 Year warranty
- Safety terminal block connector
- Very compact design

ORDERING CODE

FIN1700EG .070 .M
 Model Current (A) Connection
 M = Terminal block

ATTENUATION INDICATOR

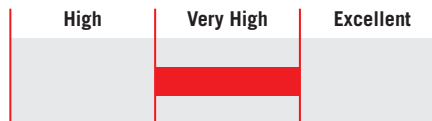

ELECTRIC DIAGRAM

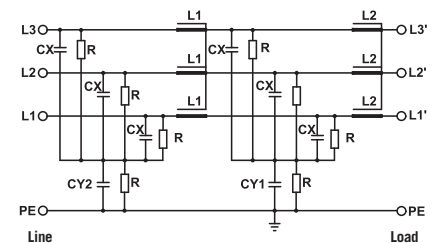

TECHNICAL SPECIFICATIONS

Nominal voltage	0 / 500 Vac
Frequency	50 – 60 Hz
Rated current	7 to 230A
Potential test voltage phase to phase	2300 Vdc (2 sec.)
Potential test voltage phase to ground	3100 Vdc (2 sec.)
Leakage current normal conditions	< 3 mA *
Leakage current worst conditions	< 15 mA
IP Protection	IP20
Overload capability	4 x Rated current (Switch ON) 2 x In 10 seconds 1.5 In for 10 minutes
Climatic class	-40 / +85° C
MTBF at 40°C	250.000 Hrs

* Voltage 230 Vac phase to ground 50 Hz / 40°C

ELECTRICAL CHARACTERISTICS

FIN1700EG	Rated Current 40°C	Rated Current 50°C	Power Loss (W)
.007.M	7	6	8
.013.M	13	12	12
.018.M	18	16	15
.027.M	27	25	20
.034.M	34	32	32
.040.M	40	36	23
.055.M	55	50	42
.070.M	70	64	55
.100.M	100	90	60
.110.M	110	100	90
.130.M	130	120	98
.150.M	150	135	103
.200.M	200	180	115
.230.M	230	210	120

CONNECTIONS

LINE			PE	
Solid Cable (mm ²)	Stranded Cable (mm ²)	Terminal Torque (Nm)	d (mm)	Torque (Nm)
0.2 - 10	0.2 - 6	1.2	M6	6
0.2 - 10	0.2 - 6	1.2	M6	6
0.2 - 10	0.2 - 6	1.2	M6	6
0.2 - 10	0.2 - 6	1.2	M6	6
0.2 - 10	0.2 - 6	1.2	M6	6
0.2 - 10	0.2 - 6	1.2	M6	6
0.5 - 16	0.5 - 10	1.8	M6	6
0.5 - 16	0.5 - 10	1.8	M6	6
4 - 25	6 - 35	4.5	M10	18
4 - 25	6 - 35	4.5	M10	18
10 - 50	10 - 50	4	M10	18
10 - 50	10 - 50	4	M10	18
35 - 95	35 - 95	20	M10	18
35 - 95	35 - 95	20	M10	18

TYPICAL ATTENUATION

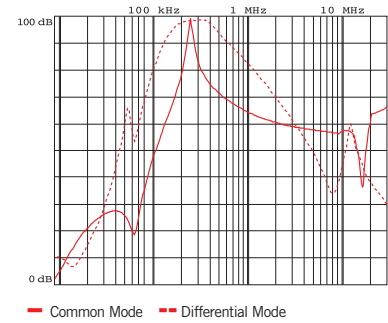

MECHANICAL DIMENSIONS mm

FIN1700EG	A	B	V	V1	F	H	I	L	N	d	Weight Kg.	Case
.007.M	140	50	19	15	6	226	200	7	28	M6	1.7	1
.013.M	140	50	19	15	6	226	200	7	28	M6	1.7	1
.018.M	140	50	19	15	6	226	200	7	28	M6	1.7	1
.027.M	140	50	19	15	6	226	200	7	28	M6	1.7	1
.034.M	140	50	19	15	6	226	200	7	28	M6	1.7	1
.040.M	140	50	19	15	6	226	200	7	28	M6	1.7	1
.055.M	177	70	19	25	6	295	265	8	44	M6	3.7	1
.070.M	177	70	19	33	6	295	265	8	44	M6	5.2	1
.100.M	205	80	28.5	38	8	390	340	12	53	M10	6.5	1
.110.M	205	80	28.5	38	8	390	340	12	53	M10	6.5	1
.130.M	205	80	28.5	43	8	390	340	12	53	M10	7.1	1
.150.M	205	80	28.5	43	8	390	340	12	53	M10	7.1	1
.200.M	220	105	28.5	50	8	420	370	12	78	M10	8	1
.230.M	220	105	28.5	50	8	420	370	12	78	M10	8	1

CASE 1

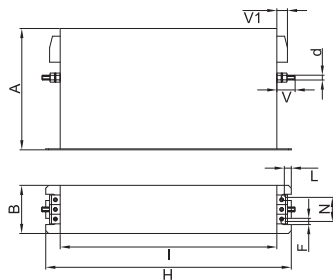

ASSEMBLY CONNECTION "M"

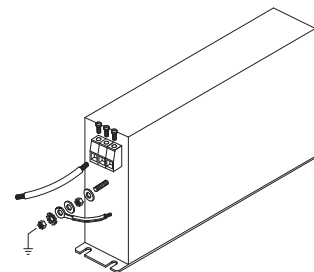



EMI/RFI Filter with very high attenuation for IT network applications

Datasheet 3/2019

APPROVALS:



FIN1700IT.(006 - 200).M

Models available with current ratings up to 2500A

FEATURES

- Rated current from 6 to 200A
- Very high differential and common mode attenuation
- Very low leakage current
- Designed for IT networks

BENEFITS

- 5 Year warranty
- Safety terminal block connector
- Available up to 2500A

MARKETS

- IT networks
- Semiconductor machinery

ORDERING CODE

FIN1700IT .055 .M
 Model Current (A) Connection
 M = Terminal block

ATTENUATION INDICATOR

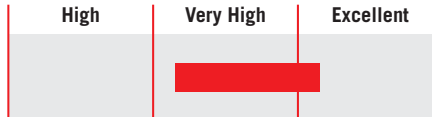

ELECTRIC DIAGRAM

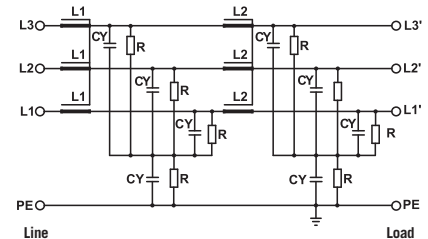

TECHNICAL SPECIFICATIONS

Nominal voltage	0 / 600 Vac
Frequency	50 – 60 Hz
Rated current	6 to 200A
Potential test voltage phase to phase	2700 Vdc (2 sec.)
Potential test voltage phase to ground	3200 Vdc (2 sec.)
Leakage current normal conditions	< 1 mA *
Leakage current worst conditions	< 3 mA
IP Protection	IP20 up to 200A
Overload capability	4 x Rated current (Switch ON) 2 x In 10 seconds 1.5 In for 10 minutes
Climatic class	-40 / +85° C
MTBF at 40°C	250.000 Hrs

* Voltage 230 Vac phase to ground 50 Hz / 40°C

ELECTRICAL CHARACTERISTICS

FIN1700IT	Rated Current 40°C	Rated Current 50°C	Power Loss (W)
.006.M	8	6	8
.012.M	14	12	10
.016.M	18	16	12
.025.M	28	25	15
.032.M	35	32	23
.042.M	50	42	32
.055.M	63	55	37
.070.M	80	70	52
.080.M	90	80	60
.100.M	110	100	92
.115.M	130	115	101
.150.M	175	150	115
.200.M	230	200	120

CONNECTIONS

LINE			PE	
Solid Cable (mm ²)	Stranded Cable (mm ²)	Terminal Torque (Nm)	d (mm)	Torque (Nm)
0.2 - 10	0.2 - 6	1.2	M6	6
0.2 - 10	0.2 - 6	1.2	M6	6
0.2 - 10	0.2 - 6	1.2	M6	6
0.2 - 10	0.2 - 6	1.2	M6	6
0.2 - 10	0.2 - 6	1.2	M6	6
0.5 - 16	0.5 - 10	1.8	M6	6
0.5 - 16	0.5 - 10	1.8	M6	6
4 - 25	6 - 35	4.5	M10	18
4 - 25	6 - 35	4.5	M10	18
10 - 50	10 - 50	4	M10	18
10 - 50	10 - 50	4	M10	18
35 - 95	35 - 95	20	M10	18
35 - 95	35 - 95	20	M10	18

TYPICAL ATTENUATION

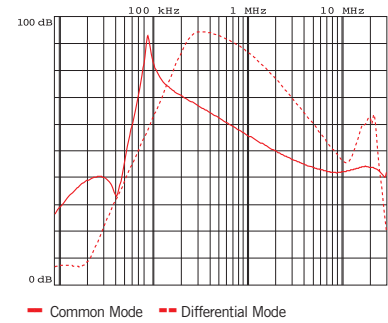

MECHANICAL DIMENSIONS mm

FIN1700IT	A	B	V	V1	F	H	I	L	N	d	Weight Kg.	Case
.006.M	140	50	19	15	6	226	200	7	28	M6	1.7	1
.012.M	140	50	19	15	6	226	200	7	28	M6	1.7	1
.016.M	177	60	19	15	6	267	237	8	34	M6	1.7	1
.025.M	177	60	19	15	6	267	237	8	34	M6	2.3	1
.032.M	177	60	19	15	6	267	237	8	34	M6	2.3	1
.042.M	177	70	19	25	6	295	265	8	44	M6	3.4	1
.055.M	177	70	19	33	6	295	265	8	44	M6	3.5	1
.070.M	205	80	28	38	8	390	340	12	53	M10	6	1
.080.M	205	80	28	38	8	390	340	12	53	M10	6	1
.100.M	205	80	28	43	8	390	340	12	53	M10	7.1	1
.115.M	205	80	28	43	8	390	340	12	53	M10	7.1	1
.150.M	220	105	28	50	8	420	370	12	78	M10	8.5	1
.200.M	220	105	28	50	8	420	370	12	78	M10	8.5	1

CASE 1

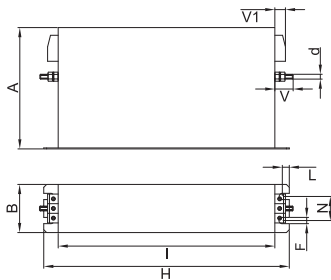

ASSEMBLY CONNECTION "M"

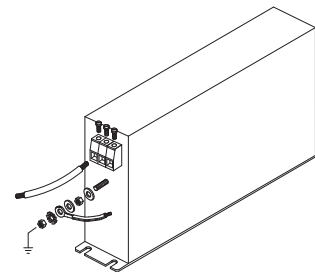



EMI/RFI Filter with excellent attenuation for industrial applications

Datasheet 3/2019



FIN1900.(006 – 200).M

FEATURES

- Rated current from 6 to 200A
- Excellent differential and common mode attenuation
- Low leakage current

MARKETS

- Machine tools
- Packaging machinery
- Semiconductor machinery
- Processing machinery

APPROVALS:

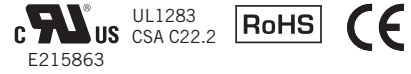

SCCR by UL508A

BENEFITS

- 5 Year warranty
- Safety terminal block connector
- Helps pass immunity and emission tests for the IEC61000-6-2 and IEC61000-6-4 Standards

ORDERING CODE

FIN1900 .055 .M
 Model Current (A) Connection
 M = Terminal block

ATTENUATION INDICATOR

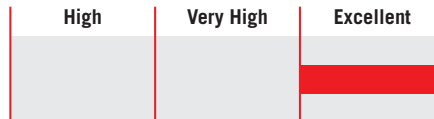

ELECTRIC DIAGRAM

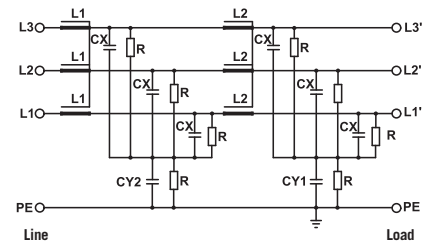

TECHNICAL SPECIFICATIONS

Nominal voltage	0 / 600 Vac
Frequency	50 – 60 Hz
Rated current	6 to 200A
Potential test voltage phase to phase	2400 Vdc (2 sec.)
Potential test voltage phase to ground	3200 Vdc (2 sec.)
Leakage current normal conditions	< 10 mA *
Leakage current worst conditions	< 80 mA
IP Protection	IP20
Overload capability	4 x Rated current (Switch ON) 2 x In 10 seconds 1.5 In for 10 minutes
Climatic class	-40 / +85° C
MTBF at 40°C	250.000 Hrs

* Voltage 230 Vac phase to ground 50 Hz / 40°C

ELECTRICAL CHARACTERISTICS

FIN1900	Rated Current 40°C	Rated Current 50°C	Power Loss (W)
.006.M	8	6	8
.012.M	14	12	10
.016.M	18	16	12
.025.M	28	25	15
.032.M	35	32	23
.042.M	50	42	32
.055.M	63	55	37
.070.M	80	70	52
.080.M	90	80	60
.100.M	110	100	92
.115.M	130	115	101
.150.M	175	150	115
.200.M	230	200	120

CONNECTIONS

LINE			PE	
Solid Cable (mm ²)	Stranded Cable (mm ²)	Terminal Torque (Nm)	d (mm)	Torque (Nm)
0.2 - 10	0.2 - 6	1.2	M6	6
0.2 - 10	0.2 - 6	1.2	M6	6
0.2 - 10	0.2 - 6	1.2	M6	6
0.2 - 10	0.2 - 6	1.2	M6	6
0.2 - 10	0.2 - 6	1.2	M6	6
0.5 - 16	0.5 - 10	1.8	M6	6
0.5 - 16	0.5 - 10	1.8	M6	6
4 - 25	6 - 35	4.5	M10	18
4 - 25	6 - 35	4.5	M10	18
10 - 50	10 - 50	4	M10	18
10 - 50	10 - 50	4	M10	18
35 - 95	35 - 95	20	M10	18
35 - 95	35 - 95	20	M10	18

TYPICAL ATTENUATION

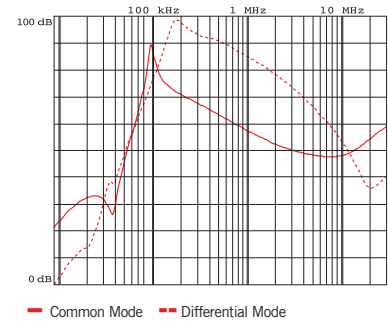

MECHANICAL DIMENSIONS mm

FIN1900	A	B	V	V1	F	H	I	L	N	d	Weight Kg.	Case
.006.M	140	50	19	15	6	226	200	7	28	M6	1.7	1
.012.M	140	50	19	15	6	226	200	7	28	M6	1.7	1
.016.M	177	60	19	15	6	267	237	8	34	M6	1.7	1
.025.M	177	60	19	15	6	267	237	8	34	M6	2.3	1
.032.M	177	60	19	15	6	267	237	8	34	M6	2.3	1
.042.M	177	70	19	25	6	295	265	8	44	M6	3.4	1
.055.M	177	70	19	33	6	295	265	8	44	M6	3.5	1
.070.M	205	80	28	38	8	390	340	12	53	M10	6	1
.080.M	205	80	28	38	8	390	340	12	53	M10	6	1
.100.M	205	80	28	43	8	390	340	12	53	M10	7.1	1
.115.M	205	80	28	43	8	390	340	12	53	M10	7.1	1
.150.M	220	105	28	50	8	420	370	12	78	M10	8.5	1
.200.M	220	105	28	50	8	420	370	12	78	M10	8.5	1

CASE 1

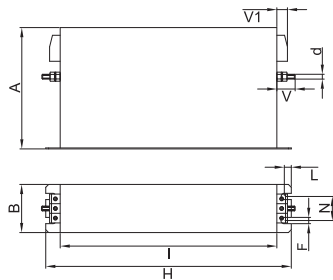

ASSEMBLY CONNECTION "M"

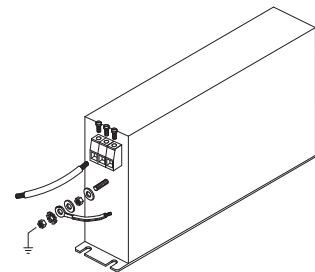



EMI/RFI Filter with excellent attenuation for industrial applications

Datasheet 3/2019



FIN1900G.(006 – 200).M

FEATURES

- Rated current from 6 to 200A
- Excellent differential and common mode attenuation
- Low leakage current
- High attenuation in the low frequency range 100 kHz – 2 MHz

MARKETS

- Machine tools
- Packaging machinery
- Semiconductor machinery
- Processing machinery

APPROVALS:



SCCR by UL508A

BENEFITS

- 5 Year warranty
- Safety terminal block connector
- Helps pass immunity and emission tests for the IEC61000-6-2 and IEC61000-6-4 Standards

ORDERING CODE

FIN1900G .055 .M
 Model Current (A) Connection
 M = Terminal block

ATTENUATION INDICATOR



ELECTRIC DIAGRAM

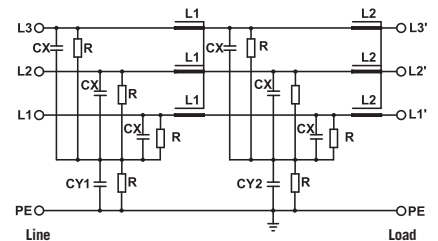

TECHNICAL SPECIFICATIONS

Nominal voltage	0 / 600 Vac
Frequency	50 – 60 Hz
Rated current	6 to 200A
Potential test voltage phase to phase	2400 Vdc (2 sec.)
Potential test voltage phase to ground	3200 Vdc (2 sec.)
Leakage current normal conditions	< 10 mA *
Leakage current worst conditions	< 80 mA
IP Protection	IP20
Overload capability	4 x Rated current (Switch ON) 2 x In 10 seconds 1.5 In for 10 minutes
Climatic class	-40 / +85° C
MTBF at 40°C	250.000 Hrs

* Voltage 230 Vac phase to ground 50 Hz / 40°C

ELECTRICAL CHARACTERISTICS

FIN1900G	Rated Current 40°C	Rated Current 50°C	Power Loss (W)
.006.M	8	6	8
.012.M	14	12	10
.016.M	18	16	12
.025.M	28	25	15
.032.M	35	32	23
.042.M	50	42	32
.055.M	63	55	37
.070.M	80	70	52
.080.M	90	80	60
.100.M	110	100	92
.115.M	130	115	101
.150.M	175	150	115
.200.M	230	200	120

CONNECTIONS

LINE			PE	
Solid Cable (mm ²)	Stranded Cable (mm ²)	Terminal Torque (Nm)	d (mm)	Torque (Nm)
0.2 - 10	0.2 - 6	1.2	M6	6
0.2 - 10	0.2 - 6	1.2	M6	6
0.2 - 10	0.2 - 6	1.2	M6	6
0.2 - 10	0.2 - 6	1.2	M6	6
0.2 - 10	0.2 - 6	1.2	M6	6
0.5 - 16	0.5 - 10	1.8	M6	6
0.5 - 16	0.5 - 10	1.8	M6	6
4 - 25	6 - 35	4.5	M10	18
4 - 25	6 - 35	4.5	M10	18
10 - 50	10 - 50	4	M10	18
10 - 50	10 - 50	4	M10	18
35 - 95	35 - 95	20	M10	18
35 - 95	35 - 95	20	M10	18

TYPICAL ATTENUATION

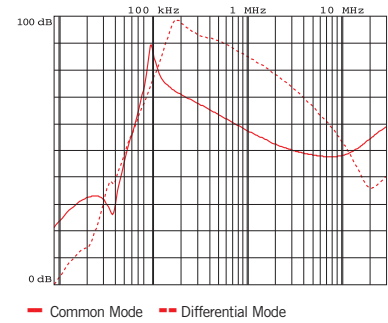

MECHANICAL DIMENSIONS mm

FIN1900G	A	B	V	V1	F	H	I	L	N	d	Weight Kg.	Case
.006.M	140	50	19	15	6	226	200	7	28	M6	1.7	1
.012.M	140	50	19	15	6	226	200	7	28	M6	1.7	1
.016.M	177	60	19	15	6	267	237	8	34	M6	1.7	1
.025.M	177	60	19	15	6	267	237	8	34	M6	2.3	1
.032.M	177	60	19	15	6	267	237	8	34	M6	2.3	1
.042.M	177	70	19	25	6	295	265	8	44	M6	3.4	1
.055.M	177	70	19	33	6	295	265	8	44	M6	3.5	1
.070.M	205	80	28	38	8	390	340	12	53	M10	6	1
.080.M	205	80	28	38	8	390	340	12	53	M10	6	1
.100.M	205	80	28	43	8	390	340	12	53	M10	7.1	1
.115.M	205	80	28	43	8	390	340	12	53	M10	7.1	1
.150.M	220	105	28	50	8	420	370	12	78	M10	8.5	1
.200.M	220	105	28	50	8	420	370	12	78	M10	8.5	1

CASE 1

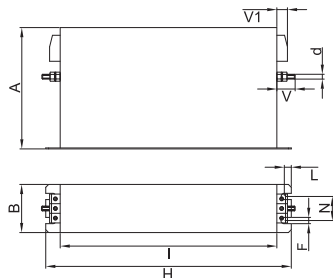

ASSEMBLY CONNECTION "M"

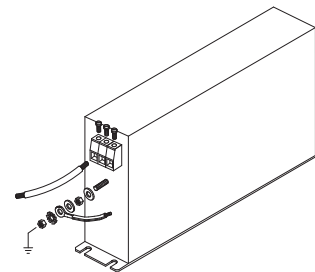



EMI/RFI Filter with excellent attenuation for industrial applications

Datasheet 3/2019



FIN1900E.(007 – 230).M

FEATURES

- Rated current from 7 to 230A
- Excellent differential and common mode attenuation
- Low leakage current

MARKETS

- Machine tools
- Laser machinery
- Recharging stations
- Uninterruptible power supplies

APPROVALS:



SCCR by UL508A

BENEFITS

- 5 Year warranty
- Safety terminal block connector
- High performance in a compact design

ORDERING CODE

FIN1900E .070 .M
 Model Current (A) Connection
 M = Terminal block

ATTENUATION INDICATOR



ELECTRIC DIAGRAM

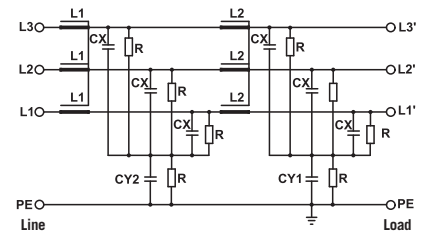

TECHNICAL SPECIFICATIONS

Nominal voltage	0 / 500 Vac
Frequency	50 – 60 Hz
Rated current	7 to 230A
Potential test voltage phase to phase	2300 Vdc (2 sec.)
Potential test voltage phase to ground	3100 Vdc (2 sec.)
Leakage current normal conditions	< 10 mA *
Leakage current worst conditions	< 80 mA
IP Protection	IP20
Overload capability	4 x Rated current (Switch ON) 2 x In 10 seconds 1.5 In for 10 minutes
Climatic class	-40 / +85° C
MTBF at 40°C	250.000 Hrs

* Voltage 230 Vac phase to ground 50 Hz / 40°C

ELECTRICAL CHARACTERISTICS

FIN1900E	Rated Current 40°C	Rated Current 50°C	Power Loss (W)
.007.M	7	6	8
.013.M	13	12	12
.018.M	18	16	15
.027.M	27	25	20
.034.M	34	32	32
.040.M	40	36	23
.055.M	55	50	42
.070.M	70	64	55
.100.M	100	90	60
.110.M	110	100	90
.130.M	130	120	98
.150.M	150	135	103
.200.M	200	180	115
.230.M	230	210	120

CONNECTIONS

LINE			PE	
Solid Cable (mm ²)	Stranded Cable (mm ²)	Terminal Torque (Nm)	d (mm)	Torque (Nm)
0.2 - 10	0.2 - 6	1.2	M6	6
0.2 - 10	0.2 - 6	1.2	M6	6
0.2 - 10	0.2 - 6	1.2	M6	6
0.2 - 10	0.2 - 6	1.2	M6	6
0.2 - 10	0.2 - 6	1.2	M6	6
0.2 - 10	0.2 - 6	1.2	M6	6
0.5 - 16	0.5 - 10	1.8	M6	6
0.5 - 16	0.5 - 10	1.8	M6	6
4 - 25	6 - 35	4.5	M10	18
4 - 25	6 - 35	4.5	M10	18
10 - 50	10 - 50	4	M10	18
10 - 50	10 - 50	4	M10	18
35 - 95	35 - 95	20	M10	18
35 - 95	35 - 95	20	M10	18

TYPICAL ATTENUATION

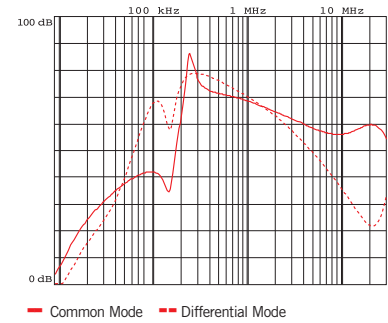

MECHANICAL DIMENSIONS mm

FIN1900E	A	B	V	V1	F	H	I	L	N	d	Weight Kg.	Case
.007.M	140	50	19	15	6	226	200	7	28	M6	1.7	1
.013.M	140	50	19	15	6	226	200	7	28	M6	1.7	1
.018.M	140	50	19	15	6	226	200	7	28	M6	1.7	1
.027.M	140	50	19	15	6	226	200	7	28	M6	1.7	1
.034.M	140	50	19	15	6	226	200	7	28	M6	1.7	1
.040.M	140	50	19	15	6	226	200	7	28	M6	1.7	1
.055.M	177	70	19	25	6	295	265	8	44	M6	3.7	1
.070.M	177	70	19	33	6	295	265	8	44	M6	5.2	1
.100.M	205	80	28.5	38	8	390	340	12	53	M10	6.5	1
.110.M	205	80	28.5	38	8	390	340	12	53	M10	6.5	1
.130.M	205	80	28.5	43	8	390	340	12	53	M10	7.1	1
.150.M	205	80	28.5	43	8	390	340	12	53	M10	7.1	1
.200.M	220	105	28.5	50	8	420	370	12	78	M10	8	1
.230.M	220	105	28.5	50	8	420	370	12	78	M10	8	1

CASE 1

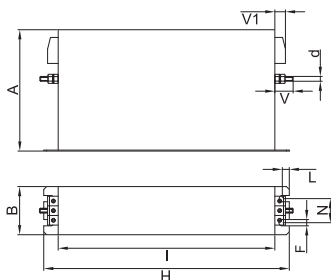

ASSEMBLY CONNECTION "M"

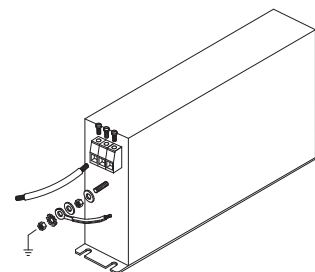



EMI/RFI Filter with excellent attenuation for industrial applications

Datasheet 3/2019



FIN1900EG.(007 – 230).M

FEATURES

- Rated current from 7 to 230A
- Excellent differential and common mode attenuation
- Low leakage current
- High attenuation in the low frequency range 100 kHz – 2 MHz

MARKETS

- Machine tools
- Laser machinery
- Recharging stations
- Uninterruptible power supplies

APPROVALS:



SCCR by UL508A

BENEFITS

- 5 Year warranty
- Safety terminal block connector
- High performance in a compact design

ORDERING CODE

FIN1900EG .070 .M
 Model Current (A) Connection
 M = Terminal block

ATTENUATION INDICATOR



ELECTRIC DIAGRAM

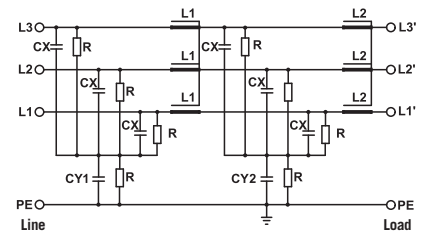

TECHNICAL SPECIFICATIONS

Nominal voltage	0 / 500 Vac
Frequency	50 – 60 Hz
Rated current	7 to 230A
Potential test voltage phase to phase	2300 Vdc (2 sec.)
Potential test voltage phase to ground	3100 Vdc (2 sec.)
Leakage current normal conditions	< 10 mA *
Leakage current worst conditions	< 80 mA
IP Protection	IP20
Overload capability	4 x Rated current (Switch ON) 2 x In 10 seconds 1.5 In for 10 minutes
Climatic class	-40 / +85° C
MTBF at 40°C	250.000 Hrs

* Voltage 230 Vac phase to ground 50 Hz / 40°C

ELECTRICAL CHARACTERISTICS

FIN1900EG	Rated Current 40°C	Rated Current 50°C	Power Loss (W)
.007.M	7	6	8
.013.M	13	12	12
.018.M	18	16	15
.027.M	27	25	20
.034.M	34	32	32
.040.M	40	36	23
.055.M	55	50	42
.070.M	70	64	55
.100.M	100	90	60
.110.M	110	100	90
.130.M	130	120	98
.150.M	150	135	103
.200.M	200	180	115
.230.M	230	210	120

CONNECTIONS

LINE			PE	
Solid Cable (mm ²)	Stranded Cable (mm ²)	Terminal Torque (Nm)	d (mm)	Torque (Nm)
0.2 - 10	0.2 - 6	1.2	M6	6
0.2 - 10	0.2 - 6	1.2	M6	6
0.2 - 10	0.2 - 6	1.2	M6	6
0.2 - 10	0.2 - 6	1.2	M6	6
0.2 - 10	0.2 - 6	1.2	M6	6
0.2 - 10	0.2 - 6	1.2	M6	6
0.5 - 16	0.5 - 10	1.8	M6	6
0.5 - 16	0.5 - 10	1.8	M6	6
4 - 25	6 - 35	4.5	M10	18
4 - 25	6 - 35	4.5	M10	18
10 - 50	10 - 50	4	M10	18
10 - 50	10 - 50	4	M10	18
35 - 95	35 - 95	20	M10	18
35 - 95	35 - 95	20	M10	18

TYPICAL ATTENUATION

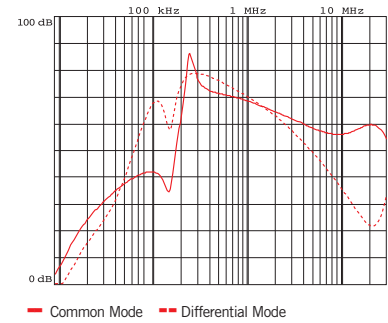

MECHANICAL DIMENSIONS mm

FIN1900EG	A	B	V	V1	F	H	I	L	N	d	Weight Kg.	Case
.007.M	140	50	19	15	6	226	200	7	28	M6	1.7	1
.013.M	140	50	19	15	6	226	200	7	28	M6	1.7	1
.018.M	140	50	19	15	6	226	200	7	28	M6	1.7	1
.027.M	140	50	19	15	6	226	200	7	28	M6	1.7	1
.034.M	140	50	19	15	6	226	200	7	28	M6	1.7	1
.040.M	140	50	19	15	6	226	200	7	28	M6	1.7	1
.055.M	177	70	19	25	6	295	265	8	44	M6	3.7	1
.070.M	177	70	19	33	6	295	265	8	44	M6	5.2	1
.100.M	205	80	28.5	38	8	390	340	12	53	M10	6.5	1
.110.M	205	80	28.5	38	8	390	340	12	53	M10	6.5	1
.130.M	205	80	28.5	43	8	390	340	12	53	M10	7.1	1
.150.M	205	80	28.5	43	8	390	340	12	53	M10	7.1	1
.200.M	220	105	28.5	50	8	420	370	12	78	M10	8	1
.230.M	220	105	28.5	50	8	420	370	12	78	M10	8	1

CASE 1

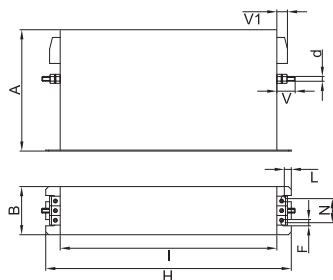

ASSEMBLY CONNECTION "M"

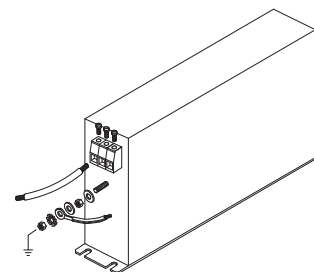



EMI/RFI Filter with excellent attenuation for industrial applications

Datasheet 3/2019



FIN1900S.(042 – 200).M

FEATURES

- Rated current from 42 to 200A
- Excellent differential and common mode attenuation
- Low leakage current

MARKETS

- CNC machinery
- Multiple axis applications
- Recharging stations
- Welding systems

APPROVALS:



SCCR by UL508A

BENEFITS

- 5 Year warranty
- Safety terminal block connector
- Helps pass immunity and emission tests for the IEC61000-6-2 and IEC61000-6-4 Standards

ORDERING CODE

FIN1900S .055 .M
 Model Current (A) Connection
 M = Terminal block

ATTENUATION INDICATOR

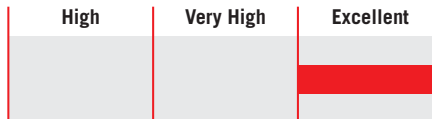

ELECTRIC DIAGRAM

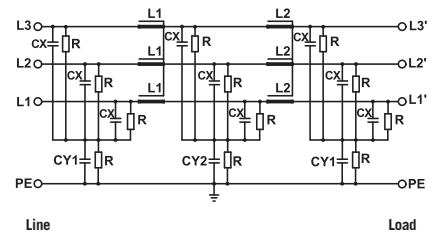

TECHNICAL SPECIFICATIONS

Nominal voltage	0 / 600 Vac
Frequency	50 – 60 Hz
Rated current	42 to 200A
Potential test voltage phase to phase	2400 Vdc (2 sec.)
Potential test voltage phase to ground	3200 Vdc (2 sec.)
Leakage current normal conditions	< 15 mA *
Leakage current worst conditions	< 150 mA
IP Protection	IP20
Overload capability	4 x Rated current (Switch ON) 2 x In 10 seconds 1.5 In for 10 minutes
Climatic class	-40 / +85° C
MTBF at 40°C	250.000 Hrs

* Voltage 230 Vac phase to ground 50 Hz / 40°C

ELECTRICAL CHARACTERISTICS

FIN1900S	Rated Current 40°C	Rated Current 50°C	Power Loss (W)
.042.M	50	42	32
.055.M	63	55	37
.070.M	80	70	52
.080.M	90	80	60
.100.M	110	100	92
.115.M	130	115	101
.150.M	175	150	115
.200.M	230	200	120

CONNECTIONS

LINE			PE	
Solid Cable (mm ²)	Stranded Cable (mm ²)	Terminal Torque (Nm)	d (mm)	Torque (Nm)
0.5 - 16	0.5 - 10	1.8	M6	6
0.5 - 16	0.5 - 10	1.8	M6	6
4 - 25	6 - 35	4.5	M10	18
4 - 25	6 - 35	4.5	M10	18
10 - 50	10 - 50	4	M10	18
10 - 50	10 - 50	4	M10	18
35 - 95	35 - 95	20	M10	18
35 - 95	35 - 95	20	M10	18

TYPICAL ATTENUATION

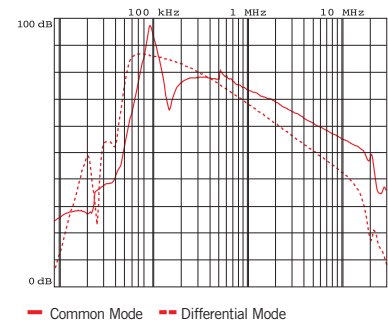

MECHANICAL DIMENSIONS mm

FIN1900S	A	B	V	V1	F	H	I	L	N	d	Weight Kg.	Case
.042.M	177	70	19	25	6	295	265	8	44	M6	3.4	1
.055.M	177	70	19	33	6	295	265	8	44	M6	3.5	1
.070.M	205	80	28	38	8	390	340	12	53	M10	6	1
.080.M	205	80	28	38	8	390	340	12	53	M10	6	1
.100.M	205	80	28	43	8	390	340	12	53	M10	7.1	1
.115.M	205	80	28	43	8	390	340	12	53	M10	7.1	1
.150.M	220	105	28	50	8	420	370	12	78	M10	8	1
.200.M	220	105	28	50	8	420	370	12	78	M10	8	1

CASE 1

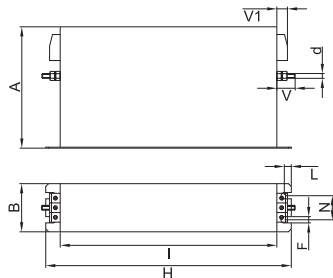

ASSEMBLY CONNECTION "M"

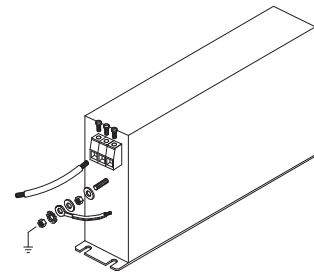



EMI/RFI Filter with very high attenuation for industrial applications

Datasheet 3/2019

APPROVALS:

UL1283
 CSA C22.2
 E215863



FIN3755.(007 – 180).M

FEATURES

- Rated current from 7 to 280A
- Very high differential and common mode attenuation
- Excellent performance and value

BENEFITS

- 5 Year warranty
- Safety terminal block connector
- Extremely compact design



FIN3755.280.B

MARKETS

- Variable frequency drives / servo drives
- Automated machinery
- Packaging machinery
- HVAC systems

ORDERING CODE

FIN3755	.055	.M
Model	Current (A)	Connection
		M = Terminal block
		B = bus bar

ATTENUATION INDICATOR

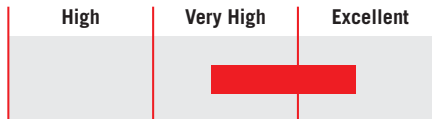

ELECTRIC DIAGRAM

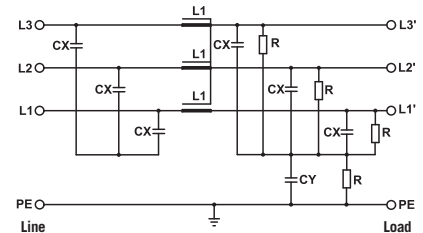

TECHNICAL SPECIFICATIONS

Nominal voltage	0 / 480 Vac
Frequency	50 – 60 Hz
Rated current	7 to 280A
Potential test voltage phase to phase	2200 Vdc (2 sec.)
Potential test voltage phase to ground	2900 Vdc (2 sec.)
Leakage current normal conditions	< 10 mA *
Leakage current worst conditions	< 80 mA
IP Protection	IP20 up to 180A IP00 over 180A
Overload capability	4 x Rated current (Switch ON) 2 x In 10 seconds 1.5 In for 10 minutes
Climatic class	-40 / +85° C
MTBF at 40°C	250.000 Hrs

* Voltage 230 Vac phase to ground 50 Hz / 40°C

ELECTRICAL CHARACTERISTICS

FIN3755	Rated Current 40°C	Rated Current 50°C	Power Loss (W)
.007.M	8	7	3
.016.M	18	16	4
.030.M	32	30	11
.042.M	45	42	15
.055.M	58	55	19
.075.M	80	75	25
.100.M	105	100	42
.150.M	160	150	52
.180.M	190	180	61

FIN3755	Rated Current 40°C	Rated Current 50°C	Power Loss (W)
.280.B	280	250	75

CONNECTIONS

LINE			PE	
Solid Cable (mm ²)	Stranded Cable (mm ²)	Terminal Torque (Nm)	d (mm)	Torque (Nm)
0.2 - 4	0.2 - 4	0.5	M5	4
0.2 - 4	0.2 - 4	0.5	M5	4
0.2 - 10	0.2 - 6	1.2	M6	6
0.2 - 10	0.2 - 6	1.2	M6	6
0.5 - 16	0.5 - 10	1.8	M6	6
4 - 25	6 - 35	4.5	M6	6
4 - 25	6 - 35	4.5	M10	18
10 - 50	10 - 50	20	M10	18
35 - 95	35 - 95	20	M10	18

LINE		PE	
d (mm)	Torque (Nm)	d 1 (Nm)	Torque (Nm)
M8	14	M8	14

TYPICAL ATTENUATION

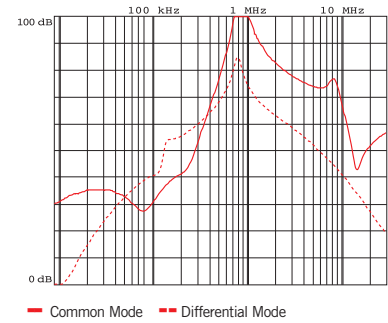

MECHANICAL DIMENSIONS mm

FIN3755	A	B	C	D	E	F	G	d	I	Weight Kg.	Case
.007.M	160	180	190	78	48	20	4	M5	1	1.1	1
.016.M	220	235	250	85	48	25	5	M5	1	1.5	1
.030.M	240	255	270	85	50	30	5	M6	1	2.1	1
.042.M	280	295	310	85	50	30	5	M6	1	2.7	1
.055.M	220	235	250	100	90	60	5	M6	1	3.1	1
.075.M	240	255	270	135	85	60	5	M6	1.5	3.6	1
.100.M	240	255	270	155	90	65	6	M10	1.5	4.2	1
.150.M	300	315	330	156.5	90	65	6	M10	1.5	6	1
.180.M	350	365	380	170	125	102	6.5	M10	1.5	7.5	1

CASE 1

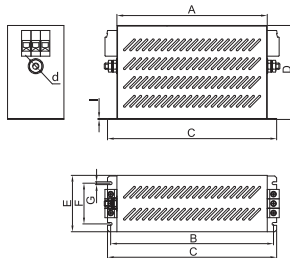

ASSEMBLY CONNECTION "M"

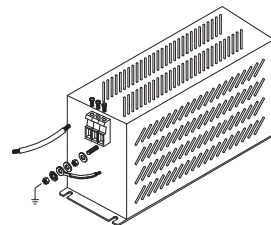

FIN3755	A	B	C	D	E	H	I	L	N	P	S	d	d2	Weight Kg.	Case
.280.B	86	200	60	300	277	300	240	275	165	320	37	9	20x6	5.2	2

CASE 2

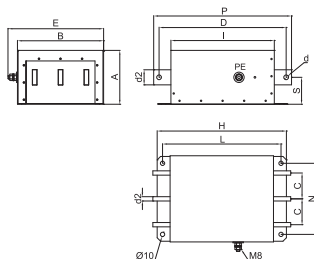

ASSEMBLY CONNECTION "B"

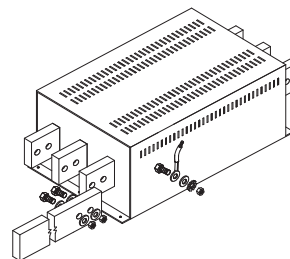



EMI/RFI Filter with very high attenuation for industrial applications

Datasheet 3/2019

APPROVALS:



FIN7213.(150 - 2000).B

Models available with current ratings up to 3000A

FEATURES

- Rated current from 150 to 2000A
- Very high differential and common mode attenuation
- Low leakage current

BENEFITS

- 5 Year warranty
- Very compact design
- Finger safe protection available
- Zero volt insulated available

MARKETS

- Electrical equipment
- Machine tools
- Industrial automation
- Variable frequency drives / servo drives
- Regenerative systems
- Renewable energy

ORDERING CODE

FIN7213 .280 .B
 Model Current (A) Connection
 B = Bus bar

ATTENUATION INDICATOR

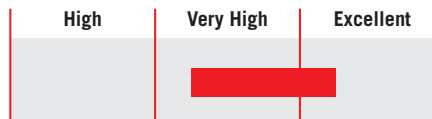

ELECTRIC DIAGRAM

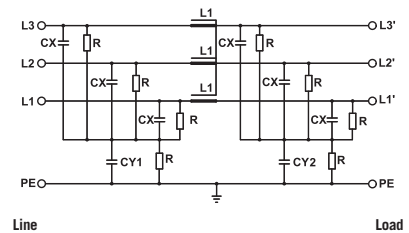

TECHNICAL SPECIFICATIONS

	FIN7213
Nominal voltage	0 / 600 Vac
Frequency	50 – 60 Hz
Rated current	150 to 2000A
Potential test voltage phase to phase	2400 Vdc (2 sec.)
Potential test voltage phase to ground	3200 Vdc (2 sec.)
Leakage current normal conditions	<10 mA*
Leakage current worst conditions	< 35 mA
IP Protection	IP00 over
Overload capability	4 x Rated current (Switch ON) 2 x In 10 seconds 1.5 In for 10 minutes
Climatic class	-40 / +85° C
MTBF at 40°C	250.000 Hrs

* Voltage 230 Vac phase to ground 50Hz / 40°C

ELECTRICAL CHARACTERISTICS

FIN7213	Rated Current 40°C	Rated Current 50°C	Power Loss (W)
.150.B	150	135	65
.200.B	200	180	70
.280.B	280	250	75
.320.B	320	290	80
.360.B	360	325	95
.400.B	400	360	110
.500.B	500	450	102
.600.B	600	540	95
.750.B	750	675	80
.800.B	800	720	82
.900.B	900	810	90
.1000.B	1000	900	100
.1250.B	1250	1120	105
.1500.B	1500	1350	110
.1750.B	1750	1500	125
.2000.B	2000	1750	132

CONNECTIONS

LINE		PE	
d (mm)	Torque (Nm)	d1 (mm)	Torque (Nm)
M8	14	M8	14
M8	14	M8	14
M8	14	M8	14
M8	14	M8	14
M8	14	M8	14
M8	14	M8	14
M8	14	M8	14
M10	18	M8	14
M10	18	M8	14
M10	18	M8	14
M10	18	M8	14
M10	18	M8	14
M10	18	M8	14
M10	18	M8	14
M10	18	M8	14
M10	18	M8	14
M10	18	M8	14

TYPICAL ATTENUATION

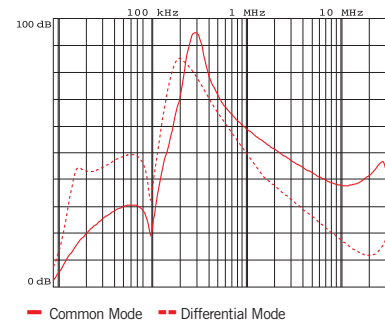

Typical attenuation 150A - 2000A

MECHANICAL DIMENSIONS mm

FIN7213	A	B	C	D	E	H	I	L	N	P	S	d	d2	Weight Kg.	Case
.150.B	86	200	60	300	227	300	240	275	165	320	37	9	20x6	5	1
.200.B	86	200	60	300	227	300	240	275	165	320	37	9	20x6	5.1	1
.280.B	86	200	60	300	227	300	240	275	165	320	37	9	20x6	5.2	1
.320.B	86	200	60	300	227	300	240	275	165	320	37	9	20x6	5.2	1
.360.B	86	200	60	300	227	300	240	275	165	320	37	9	20x6	5.3	1
.400.B	86	200	60	300	227	300	240	275	165	320	37	9	20x6	5.3	1
.500.B	125	200	60	295	222	300	240	275	200	320	62.5	11	35x10	8.2	2
.600.B	125	200	60	295	222	300	240	275	200	320	62.5	11	35x10	8.4	2
.750.B	125	200	60	295	222	300	240	275	200	320	62.5	11	35x10	8.5	2

CASE 1, 2

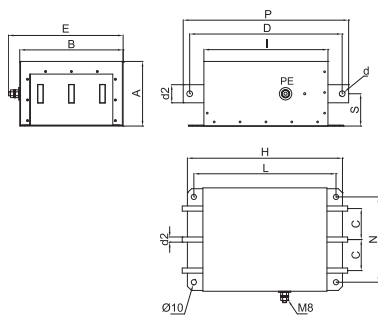

ASSEMBLY CONNECTION "B"

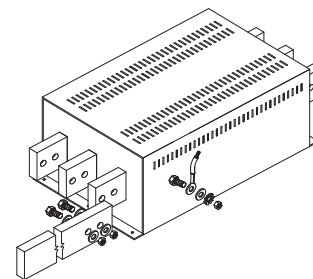

MECHANICAL DIMENSIONS mm

FIN7213	A	B	C	D	E	H	I	L	N	P	S	T	d	d2	Weight Kg.	Case
.800.B	200	250	70	380	277	300	310	280	278	460	-	430	11	50x10	8.4	3
.900.B	200	250	70	380	277	300	310	280	278	460	-	430	11	50x10	8.4	3
.1000.B	200	250	70	380	277	300	310	280	278	460	-	430	11	60x10	20.2	4
.1250.B	200	250	70	380	277	300	310	280	278	460	-	430	11	60x10	20.5	4

CASE 3, 4

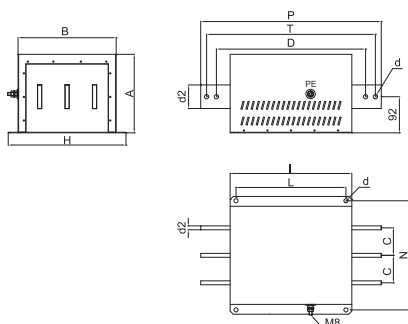

ASSEMBLY CONNECTION "B"

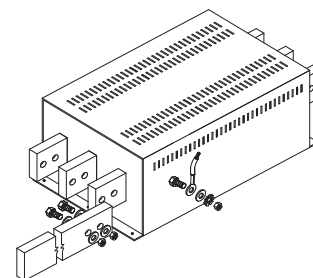

MECHANICAL DIMENSIONS mm

FIN7213	A	B	C	D	H	I	L	N	P	K	T	d	d2	Weight Kg.	Case
.1500.B	200	250	70	380	300	310	280	278	460	430	405	11	70x10	22	5
.1750.B	200	250	70	380	300	310	280	278	460	430	405	11	80x10	25	5
.2000.B	200	250	70	380	300	310	280	278	460	430	405	11	80x10	25	5

CASE 5

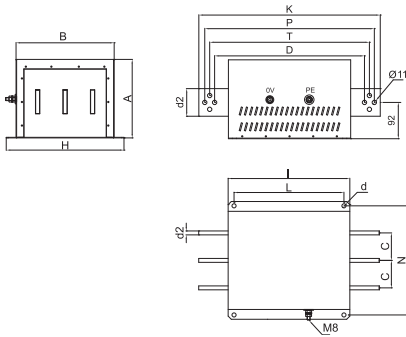

ASSEMBLY CONNECTION "B"

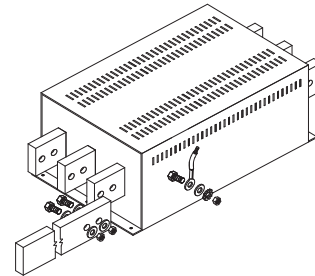



Filter Selection Guide	Description	Current Range (A)	Voltage	CONNECTORS			FEATURES						APPLICATIONS				Approval	
				Terminal Blocks	Screws	Bus Bar	Regenerative Systems	DIN Rail Mount	Long Cable Applications	Low Frequency Attenuation	Book Case Style	Very Low Leakage Current	Multiple Drives	Automation	Renewable Energy	Medical		
Three Phase + Neutral																		
FIN15	3-phase plus neutral	3-20	0-480	X				X					X				X	
FIN1240	3-phase plus neutral	5-2000	0-480	X	X	X	X			X	X		X	X		X		
FIN1740	3-phase plus neutral	6-200	0-600	X			X		X		X	X		X				
FIN1740ESM	3-phase plus neutral	10-180	0-500	X								X		X		X		
FIN1940	3-phase plus neutral	6-200	0-600	X			X		X		X		X		X			
FIN1940E	3-phase plus neutral	18-200	0-500	X						X		X	X		X			

Enerdoor three phase plus neutral series provides high attenuation in a compact case with low leakage current and is suitable for a broad range of industries.

This series carries CE and UL approvals and offers a current range from 3 to 2000A with nominal voltage up to 600 Vac.

This line offers terminal block, screw and bus bar connectors. Features include: finger safe protection for screw and bus bar connections, and DIN rail mounting for fast and easy installation within the enclosure. Customized solutions are available to satisfy various application requirements.

Three phase + neutral applications include:

- Conveyors
- Packaging machinery
- Medical equipment
- 3D printers
- Semiconductor machinery
- Automated machinery
- Woodworking machinery
- Multiple drive applications
- Laser equipment
- CNC machinery

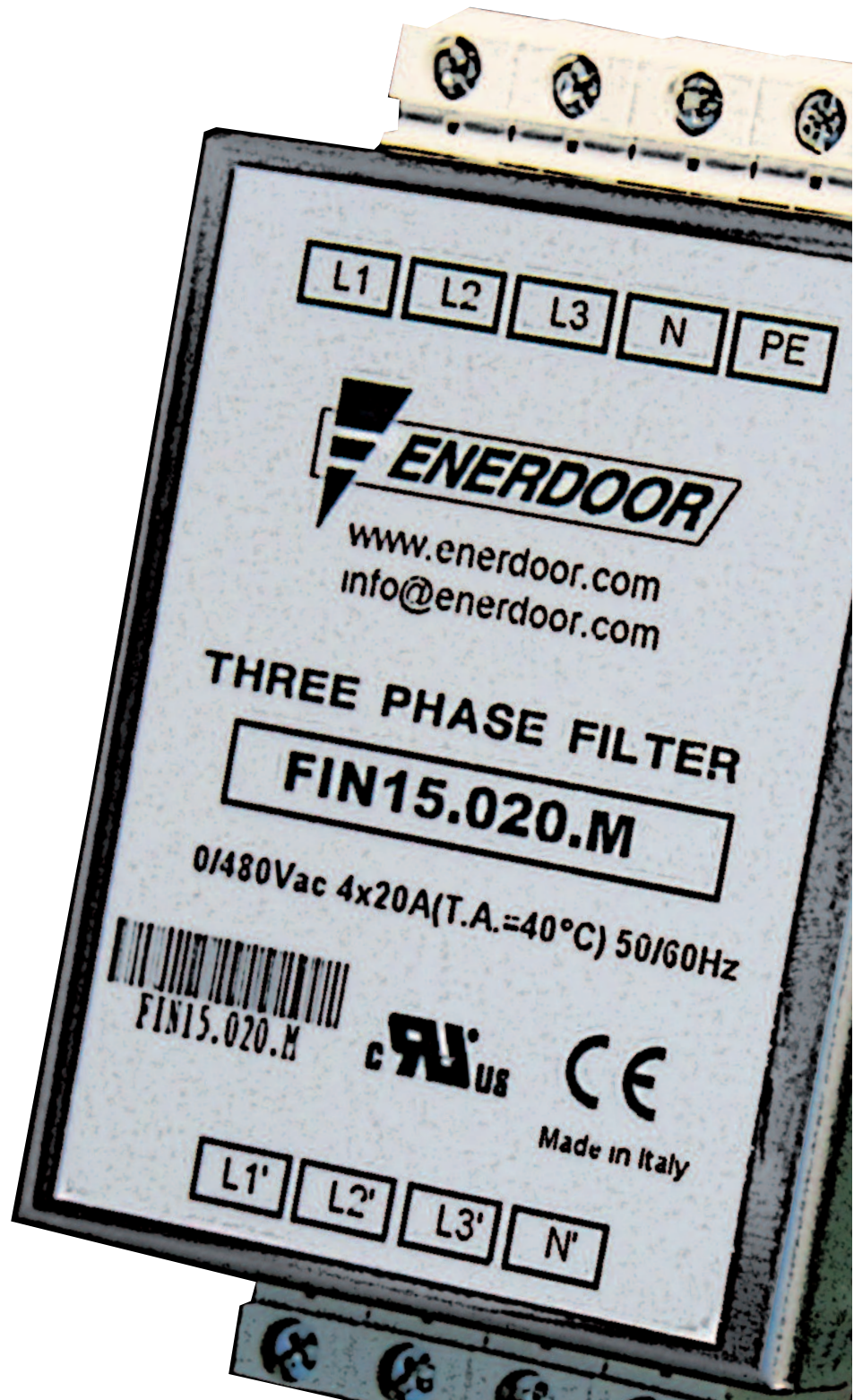



EMI/RFI Filter with high attenuation for industrial applications

Datasheet 3/2019

APPROVALS:

UL1283
CSA C22.2
E215863



SCCR by UL508A



FIN15.(003 - 020).M

FEATURES

- Rated current from 3 to 20A
- High differential and common mode attenuation
- Very low leakage current
- DIN rail mounting

BENEFITS

- 5 Year warranty
- Suitable for medical applications
- Compact design

MARKETS

- Conveyors
- Packaging machinery
- Medical equipment
- 3D printers

ORDERING CODE

FIN15 .020 .M
Model Current (A) Connection
M = Terminal block

ATTENUATION INDICATOR

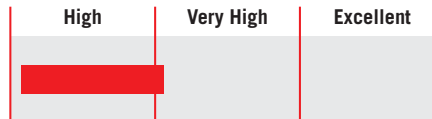

ELECTRIC DIAGRAM

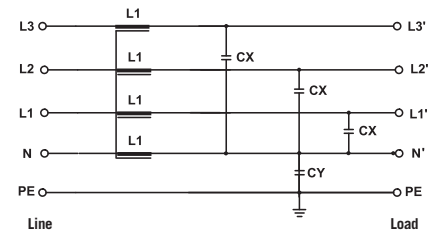

TECHNICAL SPECIFICATIONS

Nominal voltage	0 / 480 Vac
Frequency	50 – 60 Hz
Rated current	3 to 20A
Potential test voltage phase to phase	2200 Vdc (2 sec.)
Potential test voltage phase to ground	2900 Vdc (2 sec.)
Leakage current normal conditions	< 1 mA *
Leakage current worst conditions	< 3 mA
IP Protection	IP20
Overload capability	4 x Rated current (Switch ON) 2 x In 10 seconds 1.5 In for 10 minutes
Climatic class	-40 / +85° C
MTBF at 40°C	250.000 Hrs

* Voltage 230 Vac phase to ground 50 Hz / 40°C

ELECTRICAL CHARACTERISTICS

FIN15	Rated Current 40°C	Rated Current 50°C	Power Loss (W)
.003.M	3	2	1.5
.006.M	6	5	2.1
.010.M	10	8	2.8
.016.M	16	14	3.2
.020.M	20	17	4

CONNECTIONS

LINE			PE
Solid Cable (mm ²)	Stranded Cable (mm ²)	Terminal Block Torque (Nm)	Torque (Nm)
0.2 - 6	0.2 - 4	0.8	0.8
0.2 - 6	0.2 - 4	0.8	0.8
0.2 - 6	0.2 - 4	0.8	0.8
0.2 - 6	0.5 - 4	0.8	0.8
0.2 - 6	0.5 - 4	0.8	0.8

TYPICAL ATTENUATION

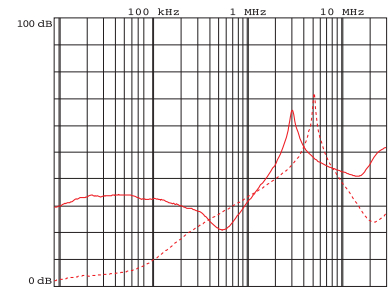

— Common Mode - - - Differential Mode

MECHANICAL DIMENSIONS mm

FIN15	A	B	H	N	Weight Kg.	Case
.003.M	65	85	39	11	0.32	1
.006.M	65	85	39	11	0.32	1
.010.M	65	85	39	11	0.32	1
.016.M	65	85	39	11	0.32	1
.020.M	65	85	39	11	0.32	1

CASE 1

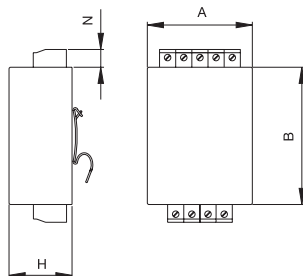

ASSEMBLY CONNECTION "M"

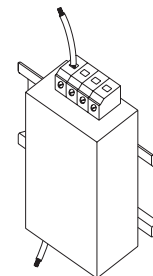



EMI/RFI Filter with excellent attenuation for industrial applications

Datasheet 3/2019

APPROVALS:

UL1283
CSA C22.2
E215863



SCCR by UL508A



FIN1240.(005 - 150).M

FEATURES

- Rated current from 5 to 2000A
- Excellent differential and common mode attenuation
- Very low leakage current

BENEFITS

- 5 Year warranty
- Suitable for medical applications
- Compact design



FIN1240.200.V

MARKETS

- Semiconductor machinery
- Medical machinery
- Automated machinery

ORDERING CODE

FIN 1240 .150 .M
Model Current (A) Connection
M = Terminal block
V = Screws
B = Bus bar



FIN1240.(360 - 1000).B

Models available with current ratings up to 2000A

ATTENUATION INDICATOR



ELECTRIC DIAGRAM

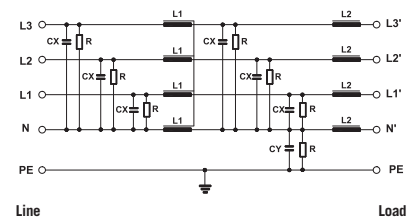

TECHNICAL SPECIFICATIONS

Nominal voltage	0 / 480 Vac
Frequency	50 – 60 Hz
Rated current	5 to 1000A
Potential test voltage phase to phase	2200 Vdc (2 sec.)
Potential test voltage phase to ground	2900 Vdc (2 sec.)
Leakage current normal conditions	< 3 mA *
Leakage current worst conditions	< 10 mA
IP Protection	IP20
Overload capability	IP00 over 200A ** 4 x Rated current (Switch ON) 2 x In 10 seconds 1.5 In for 10 minutes
Climatic class	-40 / +85° C
MTBF at 40°C	250.000 Hrs

* Voltage 230 Vac phase to ground 50 Hz / 40°C
** Protection cover available

ELECTRICAL CHARACTERISTICS

FIN1240	Rated Current 40°C	Rated Current 50°C	Power Loss (W)
.005.M	5	4	5
.010.M	10	8	7
.016.M	16	14	14
.030.M	30	27	11
.050.M	50	46	10
.080.M	80	75	35
.100.M	100	90	42
.150.M	150	140	74

CONNECTIONS

LINE			PE	
Solid Cable (mm ²)	Stranded Cable (mm ²)	Terminal Torque (Nm)	d1 (mm)	Torque (Nm)
0.2 - 10	0.2 - 6	1.2	M4	2
0.2 - 10	0.2 - 6	1.2	M4	2
0.2 - 10	0.2 - 6	1.2	M5	4
0.2 - 10	0.2 - 6	1.2	M5	4
0.5 - 16	0.5 - 10	1.8	M6	6
4 - 25	6 - 35	4.5	M8	14
4 - 25	6 - 35	4.5	M8	14
10 - 50	10 - 50	4	M10	18

TYPICAL ATTENUATION

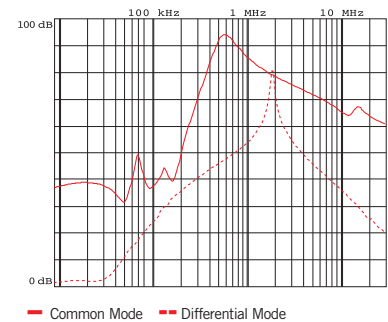

FIN1240	Rated Current 40°C	Rated Current 50°C	Power Loss (W)
.200.V	200	190	75
.360.B	360	345	96
.500.B	500	465	101
.750.B	750	710	103
.1000.B	1000	940	115

LINE		PE	
d (mm)	Torque (Nm)	d1 (mm)	Torque (Nm)
M10	18	M10	18
M8	14	M10	18
M10	25	M10	18
M12	50	M12	20
M12	50	M12	20

MECHANICAL DIMENSIONS mm

FIN1240	A	B	V	V1	F	H	I	L	N	d1	P	Weight Kg.	Case
.005.M	58	86	19	11	4.5	186	160	176	30	M4	40	1.5	1
.010.M	58	86	19	11	4.5	186	160	176	30	M4	40	1.5	1
.016.M	90	100	19	15	4.5	246	220	235	35	M5	70	2	2
.030.M	90	100	19	15	4.5	246	220	235	35	M5	70	2.5	2
.050.M	90	100	20	25	4.5	246	220	235	35	M6	70	3	3
.080.M	90	185	25	38	6.5	356	320	340	77.5	M8	70	12	4
.100.M	90	185	25	38	6.5	356	320	340	77.5	M8	70	13	4
.150.M	90	220	28	42	6.5	356	320	340	95	M10	70	15	5

CASE 1, 2, 3

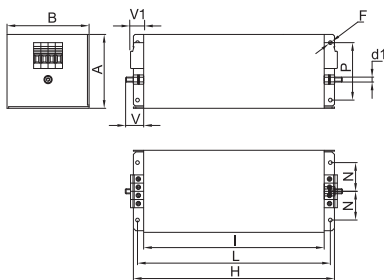

ASSEMBLY CONNECTION "M"

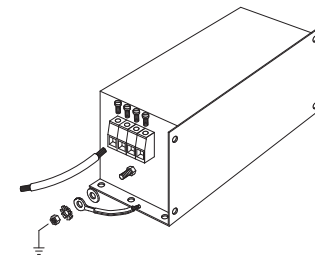

CASE 4, 5

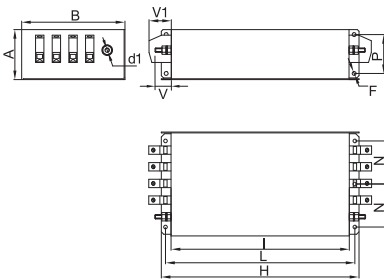

ASSEMBLY CONNECTION "M"

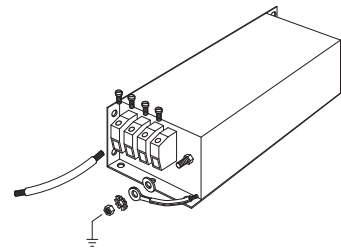

MECHANICAL DIMENSIONS mm

FIN1240	A	B	C	d	d1	d2	d3	V	F	H	I	L	N	P	S	Weight Kg.	Case
.200.V	90	220	120	M10	M10	-	-	30	6.5	356	320	340	95	70	60	20	6
.360.B	130	230	150	M8	M8	10	25	42	6.5	420	380	400	100	100	90	27	7
.500.B	130	230	150	M8	M8	15	30	48	6.5	510	450	480	100	100	90	33.5	8
.750.B	160	250	140	M10	M10	20	40	94	8.5	510	450	480	100	110	110	37	9
.1000.B	210	350	200	M12	M12	20	60	97	8.5	610	550	580	150	160	147	55	10

CASE 6

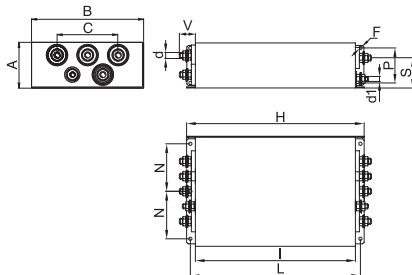

ASSEMBLY CONNECTION "V"

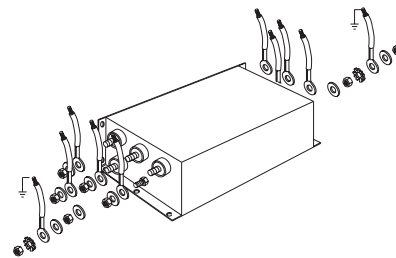

CASE 7, 8, 9, 10

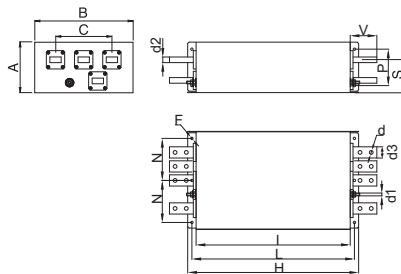

ASSEMBLY CONNECTION "B"

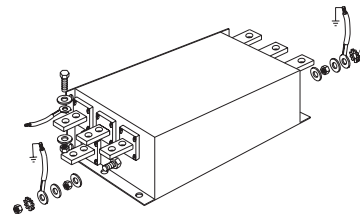



EMI/RFI Filter with excellent attenuation for industrial, residential and medical applications

Datasheet 3/2019

APPROVALS:

UL1283
CSA C22.2
E215863



SCCR by UL508A



FIN1740.(006 – 200).M

FEATURES

- Rated current from 6 to 200A
- Excellent differential and common mode attenuation
- Low leakage current
- DIN rail mounting

BENEFITS

- 5 Year warranty
- Suitable for medical applications
- Compact design

MARKETS

- Conveyors
- Packaging machinery
- Woodworking machinery
- Medical equipment

ORDERING CODE

FIN1740 .055 .M
Model Current (A) Connection
M = Terminal block

ATTENUATION INDICATOR

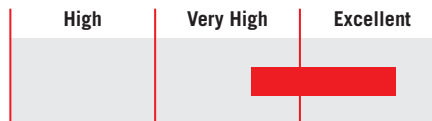

ELECTRIC DIAGRAM

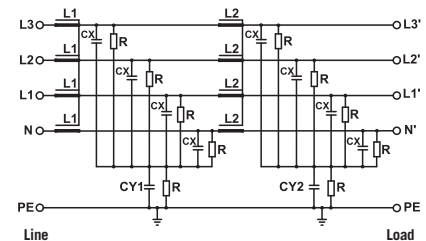

TECHNICAL SPECIFICATIONS

Nominal voltage	0 / 600 Vac
Frequency	50 – 60 Hz
Rated current	6 to 200A
Potential test voltage phase to phase	2400 Vdc (2 sec.)
Potential test voltage phase to ground	3200 Vdc (2 sec.)
Leakage current normal conditions	< 3 mA *
Leakage current worst conditions	< 15 mA
IP Protection	IP20
Overload capability	4 x Rated current (Switch ON) 2 x In 10 seconds 1.5 In for 10 minutes
Climatic class	-40 / +85° C
MTBF at 40°C	250.000 Hrs

* Voltage 230 Vac phase to ground 50 Hz / 40°C

ELECTRICAL CHARACTERISTICS

FIN1740	Rated Current 40°C	Rated Current 50°C	Power Loss (W)
.006.M	8	6	8
.012.M	14	12	10
.016.M	18	16	12
.025.M	28	25	15
.032.M	35	32	23
.042.M	50	42	32
.055.M	63	55	37
.070.M	80	70	52
.080.M	90	80	60
.100.M	110	100	92
.115.M	130	115	101
.150.M	175	150	115
.200.M	230	200	120

CONNECTIONS

LINE			PE	
Solid Cable (mm ²)	Stranded Cable (mm ²)	Terminal Torque (Nm)	d (mm)	Torque (Nm)
0.2 - 10	0.2 - 6	1.2	M6	6
0.2 - 10	0.2 - 6	1.2	M6	6
0.2 - 10	0.2 - 6	1.2	M6	6
0.2 - 10	0.2 - 6	1.2	M6	6
0.2 - 10	0.2 - 6	1.2	M6	6
0.5 - 16	0.5 - 10	1.8	M6	6
0.5 - 16	0.5 - 10	1.8	M6	6
4 - 25	6 - 35	4.5	M10	18
4 - 25	6 - 35	4.5	M10	18
10 - 50	10 - 50	4	M10	18
10 - 50	10 - 50	4	M10	18
35 - 95	35 - 95	20	M10	18
35 - 95	35 - 95	20	M10	18

TYPICAL ATTENUATION

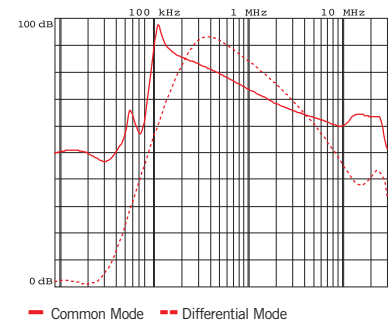

MECHANICAL DIMENSIONS mm

FIN1740	A	B	V	V1	F	H	I	L	N	d	Weight Kg.	Case
.006.M	140	60	19	16	6	226	200	7	38	M6	1.9	1
.012.M	140	60	19	16	6	226	200	7	38	M6	1.9	1
.016.M	177	70	19	16	6	267	237	8	44	M6	1.9	1
.025.M	177	70	19	16	6	267	237	8	44	M6	2.5	1
.032.M	177	70	19	16	6	267	237	8	44	M6	2.5	1
.042.M	177	80	19	34	6	295	265	8	54	M6	3.7	1
.055.M	177	80	19	33	6	295	265	8	54	M6	3.9	1
.070.M	205	100	28.5	38	8	390	340	12	73	M10	6.2	1
.080.M	205	100	28.5	38	8	390	340	12	73	M10	6.2	1
.100.M	205	100	28.5	43	8	390	340	12	73	M10	7.5	1
.115.M	205	100	28.5	43	8	390	340	12	73	M10	7.5	1
.150.M	220	130	28.5	50	8	420	370	12	103	M10	9.4	1
.200.M	220	130	28.5	50	8	420	370	12	103	M10	9.4	1

CASE 1

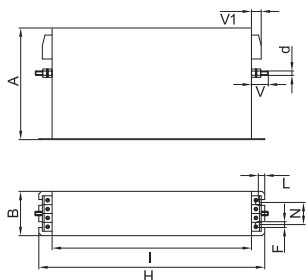

ASSEMBLY CONNECTION "M"

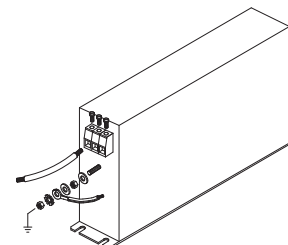



EMI/RFI Filter with very high attenuation for industrial applications

Datasheet 3/2019

APPROVALS:

UL1283
CSA C22.2
E215863



SCCR by UL508A



FIN1740ESM.(010 – 180).M

FEATURES

- Rated current from 10 to 180A
- Very high differential and common mode attenuation
- Low leakage current

BENEFITS

- 5 Year warranty
- Suitable for medical applications
- Compact design

MARKETS

- Conveyors
- Automated machinery
- 3D printers
- Medical equipment

ORDERING CODE

FIN 1740ESM .072 .M
Model Current (A) Connection
M = Terminal block

ATTENUATION INDICATOR

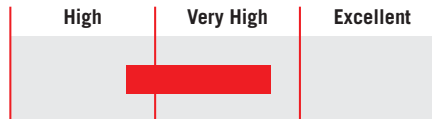

ELECTRIC DIAGRAM

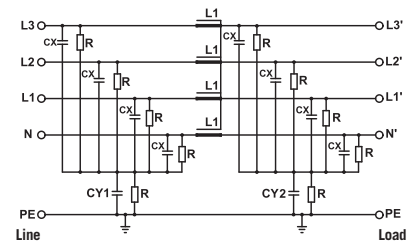

TECHNICAL SPECIFICATIONS

Nominal voltage	0 / 500 Vac
Frequency	50 – 60 Hz
Rated current	10 to 180A
Potential test voltage phase to phase	2300 Vdc (2 sec.)
Potential test voltage phase to ground	3100 Vdc (2 sec.)
Leakage current normal conditions	< 3 mA *
Leakage current worst conditions	< 15 mA
IP Protection	IP20
Overload capability	4 x Rated current (Switch ON) 2 x In 10 seconds 1.5 In for 10 minutes
Climatic class	-40 / +85° C
MTBF at 40°C	250.000 Hrs

* Voltage 230 Vac phase to ground 50 Hz / 40°C

ELECTRICAL CHARACTERISTICS

FIN1740ESM	Rated Current 40°C	Rated Current 50°C	Power Loss (W)
.010.M	10	9	5
.018.M	18	16	5
.036.M	36	32	18
.072.M	72	64	40
.100.M	100	90	102
.135.M	135	120	96
.180.M	180	160	98

CONNECTIONS

LINE			PE	
Solid Cable (mm ²)	Stranded Cable (mm ²)	Terminal Torque (Nm)	d (mm)	Torque (Nm)
0.2 - 10	0.2 - 6	1.2	M6	6
0.2 - 10	0.2 - 6	1.2	M6	6
0.2 - 10	0.2 - 6	1.2	M6	6
0.5 - 16	0.5 - 10	1.8	M6	6
4 - 25	6 - 35	4.5	M10	18
10 - 50	10 - 50	4	M10	18
35 - 95	35 - 95	20	M10	18

TYPICAL ATTENUATION

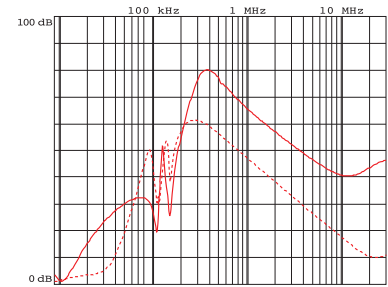

— Common Mode - - - Differential Mode

MECHANICAL DIMENSIONS mm

FIN1740ESM	A	B	V	V1	F	H	I	L	N	d	Weight Kg.	Case
.010.M	100	130	22.5	16	6.5	153	125	8.5	90	M6	1	1
.018.M	100	130	22.5	16	6.5	153	125	8.5	90	M6	1	1
.036.M	100	130	22.5	16	6.5	153	125	8.5	90	M6	1.1	1
.072.M	125	118	22.5	32.5	6.5	153	128	8.5	50	M6	1.6	1
.100.M	140	180	30	39	6.5	170	140	8.5	65	M10	3.4	1
.135.M	140	180	30	43	6.5	170	140	8.5	65	M10	4.5	1
.180.M	160	200	30	51.5	6.5	170	140	8.5	75	M10	4.8	1

CASE 1

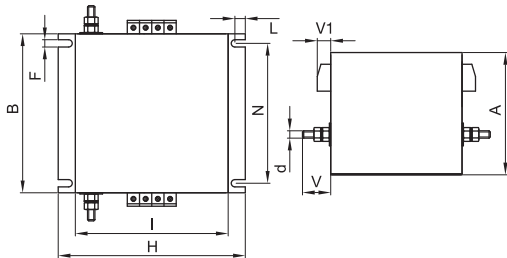

ASSEMBLY CONNECTION "M"

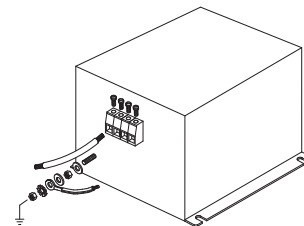



EMI/RFI Filter with excellent attenuation for industrial applications

Datasheet 3/2019

APPROVALS:

UL1283
CSA C22.2
E215863



SCCR by UL508A



FIN1940.(006 – 200).M

FEATURES

- Rated current from 6 to 200A
- Excellent differential and common mode attenuation
- Low leakage current

BENEFITS

- 5 Year warranty
- High attenuation in low frequency range
- Compact design

MARKETS

- Printing machinery
- Laser equipment
- CNC machinery
- Multiple drive installations

ORDERING CODE

FIN1940 .055 .M
Model Current (A) Connection
M = Terminal block

ATTENUATION INDICATOR

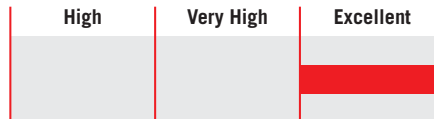

ELECTRIC DIAGRAM

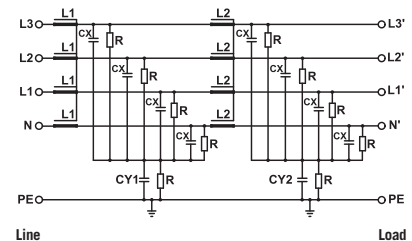

TECHNICAL SPECIFICATIONS

Nominal voltage	0 / 600 Vac
Frequency	50 – 60 Hz
Rated current	6 to 200A
Potential test voltage phase to phase	2400 Vdc (2 sec.)
Potential test voltage phase to ground	3200 Vdc (2 sec.)
Leakage current normal conditions	< 3 mA *
Leakage current worst conditions	< 15 mA
IP Protection	IP20
Overload capability	4 x Rated current (Switch ON) 2 x In 10 seconds 1.5 In for 10 minutes
Climatic class	-40 / +85° C
MTBF at 40°C	250.000 Hrs

* Voltage 230 Vac phase to ground 50 Hz / 40°C

ELECTRICAL CHARACTERISTICS

FIN1940	Rated Current 40°C	Rated Current 50°C	Power Loss (W)
.006.M	8	6	8
.012.M	14	12	10
.016.M	18	16	12
.025.M	28	25	15
.032.M	35	32	23
.042.M	50	42	32
.055.M	63	55	37
.070.M	80	70	52
.080.M	90	80	60
.100.M	110	100	92
.115.M	130	115	101
.150.M	175	150	115
.200.M	230	200	120

CONNECTIONS

LINE			PE	
Solid Cable (mm ²)	Stranded Cable (mm ²)	Terminal Torque (Nm)	d (mm)	Torque (Nm)
0.2 - 10	0.2 - 6	1.2	M6	6
0.2 - 10	0.2 - 6	1.2	M6	6
0.2 - 10	0.2 - 6	1.2	M6	6
0.2 - 10	0.2 - 6	1.2	M6	6
0.2 - 10	0.2 - 6	1.2	M6	6
0.5 - 16	0.5 - 10	1.8	M6	6
0.5 - 16	0.5 - 10	1.8	M6	6
4 - 25	6 - 35	4.5	M10	18
4 - 25	6 - 35	4.5	M10	18
10 - 50	10 - 50	4	M10	18
10 - 50	10 - 50	4	M10	18
35 - 95	35 - 95	20	M10	18
35 - 95	35 - 95	20	M10	18

TYPICAL ATTENUATION

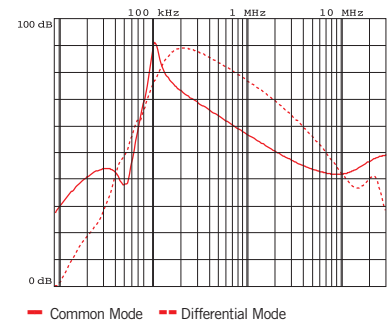

MECHANICAL DIMENSIONS mm

FIN1940	A	B	V	V1	F	H	I	L	N	d	Weight Kg.	Case
.006.M	140	60	19	16	6	226	200	7	38	M6	1.9	1
.012.M	140	60	19	16	6	226	200	7	38	M6	1.9	1
.016.M	177	70	19	16	6	267	237	8	44	M6	1.9	1
.025.M	177	70	19	16	6	267	237	8	44	M6	2.5	1
.032.M	177	70	19	16	6	267	237	8	44	M6	2.5	1
.042.M	177	80	19	34	6	295	265	8	54	M6	3.7	1
.055.M	177	80	19	33	6	295	265	8	54	M6	3.9	1
.070.M	205	100	28.5	38	8	390	340	12	73	M10	6.2	1
.080.M	205	100	28.5	38	8	390	340	12	73	M10	6.2	1
.100.M	205	100	28.5	43	8	390	340	12	73	M10	7.5	1
.115.M	205	100	28.5	43	8	390	340	12	73	M10	7.5	1
.150.M	220	130	28.5	50	8	420	370	12	103	M10	9.4	1
.200.M	220	130	28.5	50	8	420	370	12	103	M10	9.4	1

CASE 1

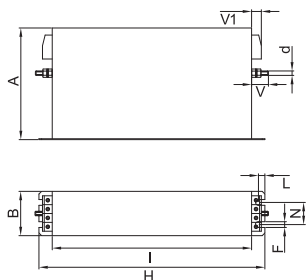

ASSEMBLY CONNECTION "M"

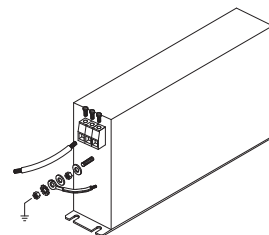



EMI/RFI Filter with excellent attenuation for industrial, residential and medical applications

Datasheet 3/2019



FIN1940E.(018 – 200).M

FEATURES

- Rated current from 18 to 200A
- Very high differential and common mode attenuation
- Very low leakage current

MARKETS

- Conveyors
- Automated machinery
- 3D printers
- Medical equipment

APPROVALS:

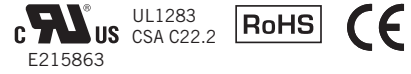

SCCR by UL508A

BENEFITS

- 5 Year warranty
- Excellent attenuation in low frequency range
- Compact design

ORDERING CODE

FIN 1940E .018 .M
 Model Current (A) Connection
 M = Terminal block

ATTENUATION INDICATOR



ELECTRIC DIAGRAM

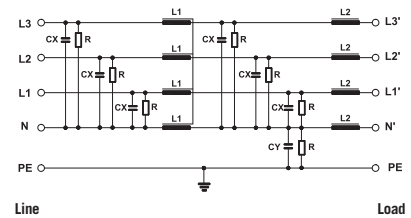

TECHNICAL SPECIFICATIONS

Nominal voltage	0 / 500 Vac
Frequency	50 – 60 Hz
Rated current	18 to 200A
Potential test voltage phase to phase	2300 Vdc (2 sec.)
Potential test voltage phase to ground	3100 Vdc (2 sec.)
Leakage current normal conditions	< 3 mA *
Leakage current worst conditions	< 15 mA
IP Protection	IP20
Overload capability	4 x Rated current (Switch ON) 2 x In 10 seconds 1.5 In for 10 minutes
Climatic class	-40 / +85° C
MTBF at 40°C	250.000 Hrs

* Voltage 230 Vac phase to ground 50 Hz / 40°C

ELECTRICAL CHARACTERISTICS

FIN1940E	Rated Current 40°C	Rated Current 50°C	Power Loss (W)
.018.M	18	16	5
.036.M	36	32	18
.072.M	72	64	40
.100.M	100	90	102
.130.M	130	120	96
.200.M	200	180	98

CONNECTIONS

LINE			PE	
Solid Cable (mm ²)	Stranded Cable (mm ²)	Terminal Torque (Nm)	d (mm)	Torque (Nm)
0.2 - 10	0.2 - 6	1.2	M5	4
0.2 - 10	0.2 - 6	1.2	M6	6
0.5 - 16	0.5 - 10	1.8	M10	18
4 - 25	6 - 35	4.5	M10	18
10 - 50	10 - 50	4	M10	18
35 - 95	35 - 95	20	M10	18

TYPICAL ATTENUATION

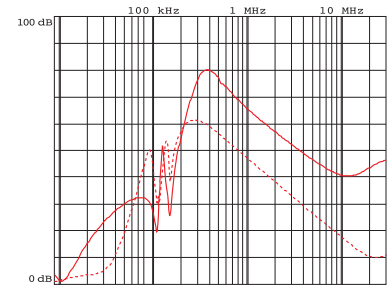

— Common Mode - - - Differential Mode

MECHANICAL DIMENSIONS mm

FIN1940E	A	B	C	D	E	F	H	d	V	V1	Weight Kg.	Case
.018.M	120	115	143	127.5	80	6.5	80	M5	23.5	11.2	1	1
.036.M	130	125	153	137.5	90	6.5	115	M6	23.5	14.5	1.1	2
.072.M	160	125	153	137.5	100	6.5	125	M10	28	32.5	1.6	3
.100.M	230	135	163	147.5	60	6.5	125	M10	27.5	38.5	3.4	4
.130.M	250	140	170	153.5	100	6.5	140	M10	27.5	43	4.5	5
.200.M	280	140	170	153.5	115	6.5	170	M10	27.5	50	4.8	6

CASE 1, 2, 3

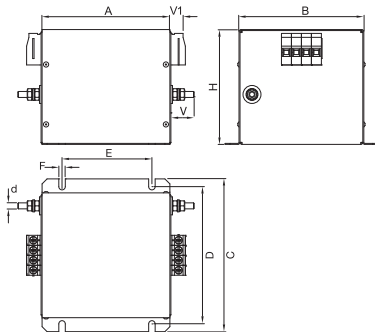

ASSEMBLY CONNECTION "M"

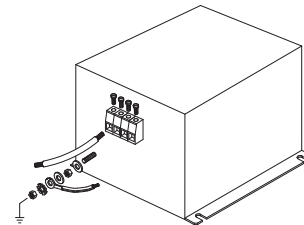

CASE 4, 5, 6

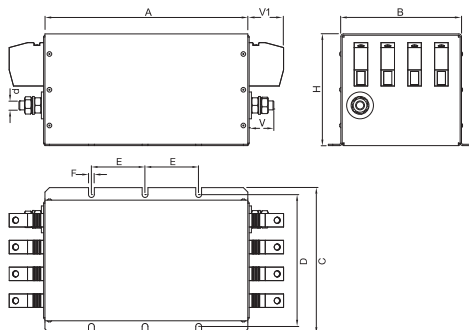

ASSEMBLY CONNECTION "M"

